

## MODEL PAX2D – 1/8 DIN DIGITAL INPUT PANEL METER



- COUNT, DUAL COUNTER WITH MATH FUNCTIONS
- RATE, DUAL RATE WITH MATH FUNCTIONS
- SLAVE DISPLAY
- UNIVERSAL AC/DC POWER SUPPLY
- 6 / 9 DIGIT DUAL LINE/TRI-COLOR DISPLAY WITH 0.71" & 0.35" DIGITS
- 10 POINT RATE SCALING FOR NON-LINEAR PROCESSES
- PROGRAMMABLE UNITS DISPLAY
- BUS CAPABILITIES; DEVICENET, MODBUS, AND PROFIBUS-DP
- BUILT-IN USB PROGRAMMING PORT ENABLING UNIT CONFIGURATION WITH CRIMSON PROGRAMMING SOFTWARE
- NEMA 4X/IP65 SEALED FRONT BEZEL

### DESCRIPTION

The PAX2D Digital Panel Meter offers many features and performance capabilities that are not available on standard panel meters. The basic meter is a dual counter and dual rate meter all in the same package. A third counter and third rate display allows the user to do simple math functions. The optional plug-in output cards allow the opportunity to configure the meter for present applications, while providing easy upgrades for future needs.

Highlighting the PAX2D is a dual line, display with a large 0.71" tri-color 6 digit top display line and a 0.35", 9 digit green bottom display line. The meter also offers programmable units display providing capability to tag the display to the units of measure. Display color change capability provides machine operators a visual indication of changing conditions, even when the operator is not close enough to read the actual display value. In addition, a universal power supply provides the ultimate in flexibility for both AC and DC inputs.

The meter accepts digital inputs from a variety of sources including switch contacts, outputs from CMOS or TTL circuits, magnetic pickups and all standard RLC sensors. The meter can process directional, uni-directional or Quadrature signals simultaneously. The meter accepts input signals up to 50 KHz maximum depending on the count mode and function configurations programmed. Each input signal can be independently scaled to various process values.

The meter provides a MAX and MIN rate reading memory with programmable capture time. The capture time is used to prevent detection of false max or min readings which may occur during start-up or unusual process events.

The meter has up to four setpoint outputs, implemented on plug-in option cards. The plug-in cards provide dual FORM-C relays, quad FORM-A, or either quad sinking or quad sourcing open collector logic outputs. The setpoint alarms can be configured to suit a variety of control and alarm requirements.

The PAX2 can be programmed to utilize Modbus protocol. With Modbus, the user has access to most configuration parameters. Readout values and setpoint alarm values can be controlled through the bus. Additionally, the meter has a feature that allows a remote computer to directly control the outputs of the meter. Communication and bus capabilities are also available as option cards. These include RS232, RS485, DeviceNet, and Profibus-DP.

The PAX2 includes a built-in USB programming port. With a Windows® based program, made available by Red Lion Controls, configuration data can be downloaded to the PAX2 without the need of any additional option cards.

A linear DC output signal is available as an optional plug-in card. The card provides either 20 mA or 10 V signals. The output can be scaled independent of the input range and can track any of the counter, rate, max or min displays, or any setpoint value.

Once the meter has been initially configured, the parameter programming may be locked out from further modification in its entirety, or only selected values can be made accessible for quick entry.

The meter has been specifically designed for harsh industrial environments. With NEMA 4X/IP65 sealed bezel and extensive testing of noise effects and CE requirements, the meter provides a tough reliable application solution.

### SAFETY SUMMARY

All safety related regulations, local codes and instructions that appear in this literature or on equipment must be observed to ensure personal safety and to prevent damage to either the instrument or equipment connected to it. If equipment is used in a manner not specified by the manufacturer, the protection provided by the equipment may be impaired. Do not use this unit to directly command motors, valves, or other actuators not equipped with safeguards. To do so can be potentially harmful to persons or equipment in the event of a fault to the unit.

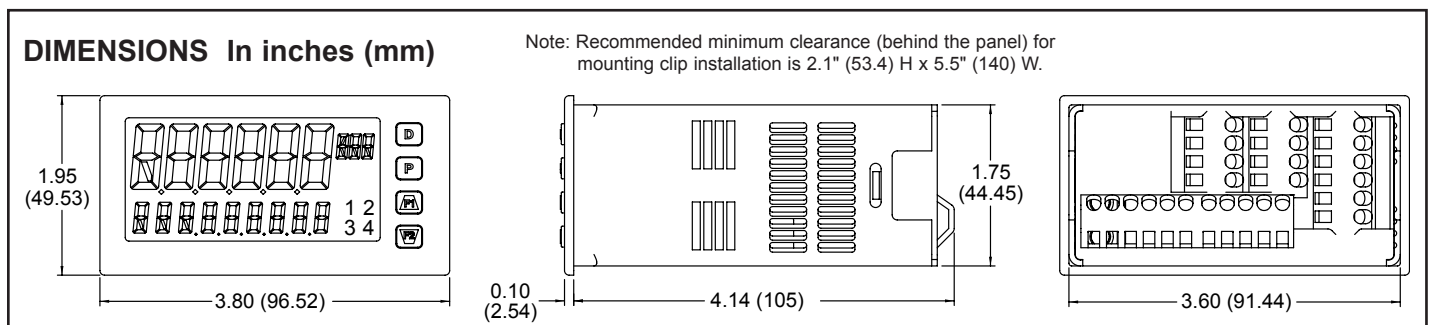
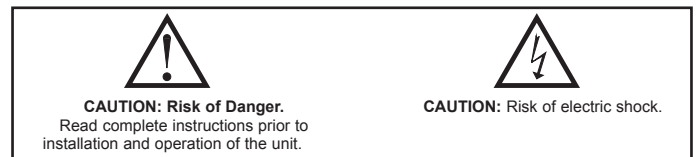

# TABLE OF CONTENTS

Ordering Information . . . . .	2	PAX2D Display Loops . . . . .	9
General Meter Specifications . . . . .	3	Programming the PAX2D . . . . .	9
Optional Plug-In Cards . . . . .	4	Serial Communications . . . . .	25
Installing the Meter . . . . .	5	PAX2D Modbus Register Table . . . . .	26
Setting the DIP Switches . . . . .	5	Factory Service Operations . . . . .	37
Installing the Plug-In Cards . . . . .	6	Troubleshooting Guide . . . . .	38
Wiring the Meter . . . . .	6	Parameter Value Chart . . . . .	38
Front Panel Keys and Display Overview . . . . .	8	Programming Quick Overview . . . . .	42

## ORDERING INFORMATION

### Meter Part Numbers

MODEL NO.	DESCRIPTION	PART NUMBER
PAX2D	Digital Input Panel Meter	PAX2D000

### Option Card and Accessories Part Numbers

TYPE	MODEL NO.	DESCRIPTION	PART NUMBER
Optional Plug-In Cards	PAXCDS	Dual Setpoint Relay Output Card	PAXCDS10
		Quad Setpoint Relay Output Card	PAXCDS20
		Quad Setpoint Sinking Open Collector Output Card	PAXCDS30
		Quad Setpoint Sourcing Open Collector Output Card	PAXCDS40
	PAXCDC <sup>1</sup>	RS485 Serial Communications Card with Terminal Block	PAXCDC10
		Extended RS485 Serial Communications Card with Dual RJ11 Connector	PAXCDC1C
		RS232 Serial Communications Card with Terminal Block	PAXCDC20
		Extended RS232 Serial Communications Card with 9 Pin D Connector	PAXCDC2C
		DeviceNet Communications Card	PAXCDC30
		Profibus-DP Communications Card	PAXCDC50
PAXCDL	Analog Output Card	PAXCDL10	
Accessories	SFCRD <sup>2</sup>	Crimson PC Configuration Software for Windows 2000, XP and Windows 7	SFCRD200
	CBLUSB	USB Programming Cable Type A-Mini B	CBLUSB01

Notes:

<sup>1</sup>. For Modbus communications use RS485 Communications Output Card and configure communication (TYPE) parameter for Modbus.

<sup>2</sup>. Crimson software is available for free download from <http://www.redlion.net/>

# GENERAL METER SPECIFICATIONS

1. **DISPLAY:** Negative image LCD  
 Top Line - 6 digit, 0.71" (18 mm), with tri-color backlight (red, green or orange), display range: -199,999 to 999,999;  
 Bottom Line - 9 digit, 0.35" (8.9 mm), with green backlight, display range: -199,999,999 to 999,999,999
2. **POWER:**  
 AC Power: 50 to 250 VAC, 50/60 Hz, 14 VA  
 DC Power: 21.6 to 250 VDC, 8 W  
 Isolation: 2300 Vrms for 1 min. to all inputs and outputs.
3. **SENSOR POWER:** +18 VDC,  $\pm 5\%$  @ 60 mA max., short circuit protected
4. **ANNUNCIATORS:**  
 Line 1 Units Display – Programmable 3 digit units annunciator with tri-color backlight (red, green or orange)  
 Setpoint Output Status Indicators - Red backlight color  
 1 - Setpoint 1 output  
 2 - Setpoint 2 output  
 3 - Setpoint 3 output  
 4 - Setpoint 4 output
5. **KEYPAD:** 2 programmable function keys, 4 keys total
6. **COUNTER DISPLAYS:** 6-digit (top line) or 9-digit (bottom line)  
 Top Line Display Range: -199,999 to 999,999  
 Bottom Line Display Range: -199,999,999 to 999,999,999  
 Over Range Display: *Over*  
 Under Range Display: *Under*  
 Display Designators: *ELR, ELB, ELI* (top line), *R, b, I* (bottom line)  
 Maximum Count Rates: 50% duty cycle, count mode dependent  
 If setpoints disabled: 35 KHz for all modes except Quadrature x4 (32 KHz)  
 If setpoint(s) enabled: 20 KHz for any mode except Quadrature x1 (19 KHz), Quadrature x2 (17 KHz) and Quadrature x4 (10 KHz)
7. **RATE DISPLAYS:** 6-digit (top or bottom line)  
 Rate A or Rate B Display Range: 0 to 999,999  
 Rate C, Rate Max (High) or Min (Low) Display Range: -199,999 to 999,999  
 Over Range Display: *Over*  
 Under Range Display: *Under*  
 Display Designators: *REL, REB, REI, H, L, Lo* (top or bottom line)  
 Maximum Frequency: 50 KHz  
 Minimum Frequency: 0.001 Hz  
 Display Update Time: 0.1 to 999.9 seconds  
 Accuracy:  $\pm 0.01\%$
8. **SIGNAL INPUTS (INPUT A and INPUT B):**  
 See Section 2.0 Setting the DIP Switches for complete input specifications.  
 DIP switch selectable inputs accept pulses from a variety of sources including switch contacts, TTL outputs, magnetic pickups and all standard RLC sensors. Inputs accept current sinking or current sourcing outputs and provide selectable input filtering for low frequency signals or switch contact debounce.
- DUAL COUNT MODES:**  
 When any dual count mode is used, then User Inputs 1 and/or 2 will accept the second signal of each signal pair. The user inputs do not have the Logic/Mag, HI/LO Freq, and Sink/Source input setup switches. The user inputs are inherently a logic input with no low frequency filtering. Any mechanical contacts used for these inputs in a dual count mode must be debounced externally. The user input may only be selected for sink/source by the User Input Active parameter (*USRACI*).
9. **USER INPUTS:** Three programmable user inputs  
 Max. Continuous Input: 30 VDC  
 Isolation To Sensor Input Common: Not isolated.  
 Response Time: 12 msec. max.  
 Logic State: User Selectable for sinking (active low) or sourcing (active high)
- | INPUT STATE | SINKING INPUTS                | SOURCING INPUTS        |
|-------------|-------------------------------|------------------------|
|             | 20K $\Omega$ pull-up to +3.3V | 20K $\Omega$ pull-down |
| Active      | $V_{IN} < 1.1$ VDC            | $V_{IN} > 2.2$ VDC     |
| Inactive    | $V_{IN} > 2.2$ VDC            | $V_{IN} < 1.1$ VDC     |
10. **PRESCALER OUTPUT:**  
 NPN Open Collector:  $I_{SNK} = 100$  mA max. @  $V_{OL} = 1$  VDC max.  $V_{OH} = 30$  VDC max. Duty cycle 25% min. and 50 % max.
11. **MEMORY:** Nonvolatile memory retains all programmable parameters and count values when power is removed.

12. **ENVIRONMENTAL CONDITIONS:**  
 Operating Temperature Range: 0 to 50 °C  
 Storage Temperature Range: -40 to 60 °C  
 Vibration According to IEC 68-2-6: Operational 5 to 150 Hz, in X, Y, Z direction for 1.5 hours, 2 g.  
 Shock According to IEC 68-2-27: Operational 25 g (10 g relay), 11 msec in 3 directions.  
 Operating and Storage Humidity: 0 to 85% max. RH non-condensing  
 Altitude: Up to 2000 meters
13. **CERTIFICATIONS AND COMPLIANCES:**
- SAFETY**  
 IEC 61010-1, EN 61010-1: Safety requirements for electrical equipment for measurement, control, and laboratory use, Part 1.  
 IP65 Enclosure rating (Face only), IEC 529  
 IP20 Enclosure rating (Rear of unit), IEC 529  
 Type 4X Indoor Enclosure rating (Face only), UL50

## ELECTROMAGNETIC COMPATIBILITY

Emissions and Immunity to EN 61326:2006: Electrical Equipment for Measurement, Control and Laboratory use.

### Immunity to Industrial Locations:

Electrostatic discharge	EN 61000-4-2	Criterion A 4 kV contact discharge 8 kV air discharge
Electromagnetic RF fields	EN 61000-4-3	Criterion A 10 V/m (80 MHz to 1 GHz) 3 V/m (1.4 GHz to 2 GHz) 1 V/m (2 GHz to 2.7 GHz)
Fast transients (burst)	EN 61000-4-4	Criterion A power 2 kV I/O signal 1 kV
Surge	EN 61000-4-5	Criterion A I/O signal connected to power 2 kV power 1 kV L to L, 2 kV L to G signal 1 kV
RF conducted interference	EN 61000-4-6	Criterion A 3 Vrms
Power freq magnetic fields	EN 61000-4-8	Criterion A 30 A/m
AC power	EN 61000-4-11	Criterion A Voltage dip 0% during 1 cycle 40% during 10/12 cycle 70% during 25/30 cycle
	Short interruptions	Criterion C 0% during 250/300 cycles

### Emissions:

Emissions EN 55011 Class A

### Notes:

1. Criterion A: Normal operation within specified limits.
  2. Criterion C: Temporary loss of function where system reset occurs.
- Refer to EMC Installation Guidelines section of the bulletin for additional information.

14. **CONNECTIONS:** High compression cage-clamp terminal block  
 Wire Strip Length: 0.3" (7.5 mm)  
 Wire Gauge Capacity: One 14 AWG (2.55 mm) solid, two 18 AWG (1.02 mm) or four 20 AWG (0.61 mm)
15. **CONSTRUCTION:** This unit is rated for NEMA 4X/IP65 indoor use. IP20 Touch safe. Installation Category II, Pollution Degree 2. One piece bezel/case. Flame resistant. Synthetic rubber keypad. Panel gasket and mounting clip included.
16. **WEIGHT:** 8 oz. (226.8 g)

# OPTIONAL PLUG-IN OUTPUT CARDS



**WARNING:** Disconnect all power to the unit before installing plug-in cards.

## Adding Option Cards

The PAX2D meters can be fitted with up to three optional plug-in cards. The details for each plug-in card can be reviewed in the specification section below. Only one card from each function type can be installed at a time. The function types include Setpoint Alarms (PAXCDS), Communications (PAXCDC), and Analog Output (PAXCDL). The plug-in cards can be installed initially or at a later date.

## COMMUNICATION CARDS (PAXCDC)

A variety of communication protocols are available for the PAX2D meter. Only one PAXCDC card can be installed at a time. *Note: For Modbus communications use RS485 Communications Output Card and configure communication (TYPE) parameter for Modbus.*

PAXCDC10 - RS485 Serial (Terminal)      PAXCDC30 - DeviceNet  
PAXCDC1C - RS485 Serial (Connector)      PAXCDC50 - Profibus-DP  
PAXCDC20 - RS232 Serial (Terminal)  
PAXCDC2C - RS232 Serial (Connector)

## SERIAL COMMUNICATIONS CARD

**Type:** RS485 or RS232  
**Communication Type:** RLC Protocol (ASCII), Modbus RTU, and Modbus ASCII  
**Isolation To Sensor & User Input Commons:** 500 Vrms for 1 min.  
Working Voltage: 50 V. Not Isolated from all other commons.  
**Data:** 7/8 bits  
**Baud:** 1200 to 38,400  
**Parity:** no, odd or even  
**Bus Address:** Selectable 0 to 99 (RLC Protocol), or 1 to 247 (Modbus Protocol), Max. 32 meters per line (RS485)  
**Transmit Delay:** Selectable for 0 to 0.250 sec (+2 msec min)

## DEVICENET™ CARD

**Compatibility:** Group 2 Server Only, not UCMM capable  
**Baud Rates:** 125 Kbaud, 250 Kbaud, and 500 Kbaud  
**Bus Interface:** Phillips 82C250 or equivalent with MIS wiring protection per DeviceNet™ Volume I Section 10.2.2.  
**Node Isolation:** Bus powered, isolated node  
**Host Isolation:** 500 Vrms for 1 minute (50 V working) between DeviceNet™ and meter input common.

## PROFIBUS-DP CARD

**Fieldbus Type:** Profibus-DP as per EN 50170, implemented with Siemens SPC3 ASIC  
**Conformance:** PNO Certified Profibus-DP Slave Device  
**Baud Rates:** Automatic baud rate detection in the range 9.6 Kbaud to 12 Mbaud  
**Station Address:** 0 to 125, set by rotary switches.  
**Connection:** 9-pin Female D-Sub connector  
**Network Isolation:** 500 Vrms for 1 minute (50 V working) between Profibus network and sensor and user input commons. Not isolated from all other commons.

## PROGRAMMING SOFTWARE

Crimson® software is a Windows® based program that allows configuration of the PAX® meter from a PC. Crimson offers standard drop-down menu commands, that make it easy to program the meter. The meter's program can then be saved in a PC file for future use. Crimson can be downloaded at [www.redlion.net](http://www.redlion.net)

## SETPOINT CARDS (PAXCDS)

The PAX2D meter has 4 available setpoint alarm output plug-in cards. Only one PAXCDS card can be installed at a time. (Logic state of the outputs can be reversed in the programming.) These plug-in cards include:

PAXCDS10 - Dual Relay, FORM-C, Normally open & closed  
PAXCDS20 - Quad Relay, FORM-A, Normally open only  
PAXCDS30 - Isolated quad sinking NPN open collector  
PAXCDS40 - Isolated quad sourcing PNP open collector

## DUAL RELAY CARD

**Type:** Two FORM-C relays  
**Isolation To Sensor & User Input Commons:** 2000 Vrms for 1 min.  
Working Voltage: 240 Vrms  
**Contact Rating:**  
One Relay Energized: 5 amps @ 120/240 VAC or 28 VDC (resistive load).  
Total current with both relays energized not to exceed 5 amps  
**Life Expectancy:** 100 K cycles min. at full load rating. External RC snubber extends relay life for operation with inductive loads

## QUAD RELAY CARD

**Type:** Four FORM-A relays  
**Isolation To Sensor & User Input Commons:** 2300 Vrms for 1 min.  
Working Voltage: 250 Vrms  
**Contact Rating:**  
One Relay Energized: 3 amps @ 240 VAC or 30 VDC (resistive load).  
Total current with all four relays energized not to exceed 4 amps  
**Life Expectancy:** 100K cycles min. at full load rating. External RC snubber extends relay life for operation with inductive loads

## QUAD SINKING OPEN COLLECTOR CARD

**Type:** Four isolated sinking NPN transistors.  
**Isolation To Sensor & User Input Commons:** 500 Vrms for 1 min.  
Working Voltage: 50 V. Not Isolated from all other commons.  
**Rating:** 100 mA max @  $V_{SAT} = 0.7 V$  max.  $V_{MAX} = 30 V$

## QUAD SOURCING OPEN COLLECTOR CARD

**Type:** Four isolated sourcing PNP transistors.  
**Isolation To Sensor & User Input Commons:** 500 Vrms for 1 min.  
Working Voltage: 50 V. Not Isolated from all other commons.  
**Rating:** Internal supply: 18 VDC unregulated, 30 mA max. total  
External supply: 30 VDC max., 100 mA max. each output

## LINEAR DC OUTPUT (PAXCDL)

Either a 0(4)-20 mA or 0-10 V retransmitted linear DC output is available from the analog output plug-in card. The programmable output low and high scaling can be based on various display values. Reverse slope output is possible by reversing the scaling point positions.

PAXCDL10 - Retransmitted Analog Output Card

## ANALOG OUTPUT CARD

**Types:** 0 to 20 mA, 4 to 20 mA or 0 to 10 VDC  
**Isolation To Sensor & User Input Commons:** 500 Vrms for 1 min.  
Working Voltage: 50 V. Not Isolated from all other commons.  
**Accuracy:** 0.17% of FS (18 to 28 °C); 0.4% of FS (0 to 50 °C)  
**Resolution:** 1/3500  
**Compliance:** 10 VDC: 10 K $\Omega$  load min., 20 mA: 500  $\Omega$  load max.  
**Powered:** Self-powered  
**Response Time:** 50 msec max., 10 msec typical

# 1.0 INSTALLING THE METER

## Installation

The PAX2D meets NEMA 4X/IP65 requirements when properly installed. The unit is intended to be mounted into an enclosed panel. Prepare the panel cutout to the dimensions shown. Remove the panel latch from the unit. Slide the panel gasket over the rear of the unit to the back of the bezel. The unit should be installed fully assembled. Insert the unit into the panel cutout.

While holding the unit in place, push the panel latch over the rear of the unit so that the tabs of the panel latch engage in the slots on the case. The panel latch should be engaged in the farthest forward slot possible. To achieve a proper seal, tighten the latch screws evenly until the unit is snug in the panel (Torque to approximately 7 in-lbs [79N-cm]). Do not over-tighten the screws.

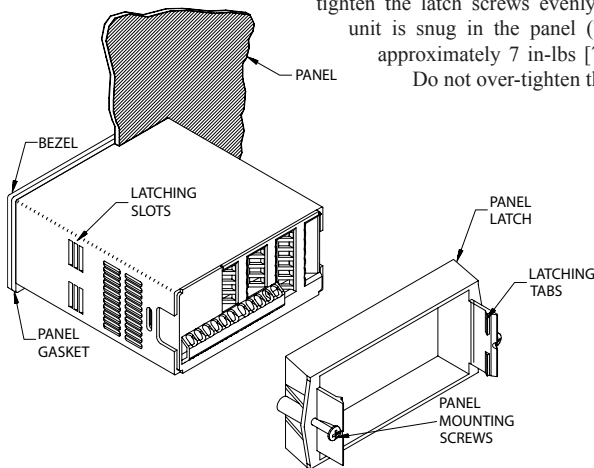

## Installation Environment

The unit should be installed in a location that does not exceed the operating temperature and provides good air circulation. Placing the unit near devices that generate excessive heat should be avoided.

The bezel should only be cleaned with a soft cloth and neutral soap product. Do NOT use solvents. Continuous exposure to direct sunlight may accelerate the aging process of the bezel.

Do not use tools of any kind (screwdrivers, pens, pencils, etc.) to operate the keypad of the unit.

### PANEL CUT-OUT

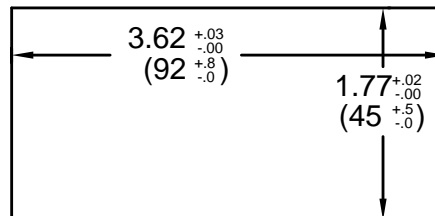

# 2.0 SETTING THE DIP SWITCHES

To access the switches, remove the meter base from the case by firmly squeezing and pulling back on the side rear finger tabs. This should lower the latch below the case slot (which is located just in front of the finger tabs). It is recommended to release the latch on one side, then start the other side latch.



**Warning:** Exposed line voltage exists on the circuit boards. Remove all power to the meter and load circuits before accessing inside of the meter.

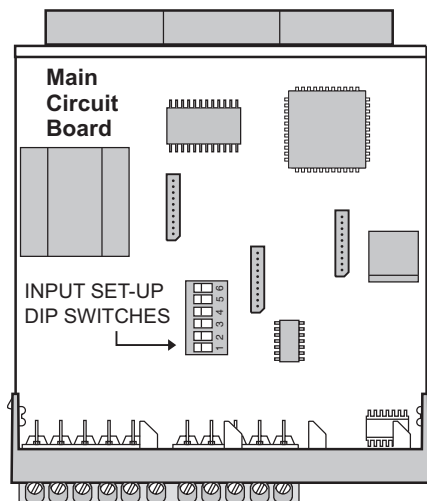

## SETTING THE INPUT DIP SWITCHES

The meter has six DIP switches for Input A and Input B terminal set-up that must be set before applying power.

Input B LO Freq.	<input type="checkbox"/>	6	HI Freq.
Input B SRC.	<input type="checkbox"/>	5	SNK.
Input B MAG.	<input type="checkbox"/>	4	Logic
Input A LO Freq.	<input type="checkbox"/>	3	HI Freq.
Input A SRC.	<input type="checkbox"/>	2	SNK.
Input A MAG.	<input type="checkbox"/>	1	Logic
	ON		

■ Factory Setting

### SWITCHES 1 and 4

**LOGIC:** Input trigger levels  $V_{IL} = 1.5$  V max.;  $V_{IH} = 3.75$  V min.

**MAG:** 200 mV peak input sensitivity; 100 mV hysteresis; maximum voltage:  $\pm 40$  V peak (28 Vrms); Input impedance: 3.9 K $\Omega$  @ 60 Hz; Must also have SRC switch ON. (Not recommended with counting applications.)

### SWITCHES 2 and 5

**SNK.:** Adds internal 7.8 K $\Omega$  pull-up resistor to +12 VDC,  $I_{MAX} = 1.9$  mA.

**SRC.:** Adds internal 3.9 K $\Omega$  pull-down resistor, 7.3 mA max. @ 28 VDC,  $V_{MAX} = 30$  VDC.

### SWITCHES 3 and 6

**HI Frequency:** Removes damping capacitor and allows max. frequency.

**LO Frequency:** Adds a damping capacitor for switch contact bounce. Also limits input frequency to maximum 50 Hz and input pulse widths to minimum 10 msec.

## 3.0 INSTALLING PLUG-IN CARDS

The plug-in cards are separately purchased optional cards that perform specific functions. These cards plug into the main circuit board of the meter. The plug-in cards have many unique functions when used with the PAX2D.



**CAUTION:** The plug-in card and main circuit board contain static sensitive components. Before handling the cards, discharge static charges from your body by touching a grounded bare metal object. Ideally, handle the cards at a static controlled clean workstation. Also, only handle the cards by the edges. Dirt, oil or other contaminants that may contact the cards can adversely affect circuit operation.

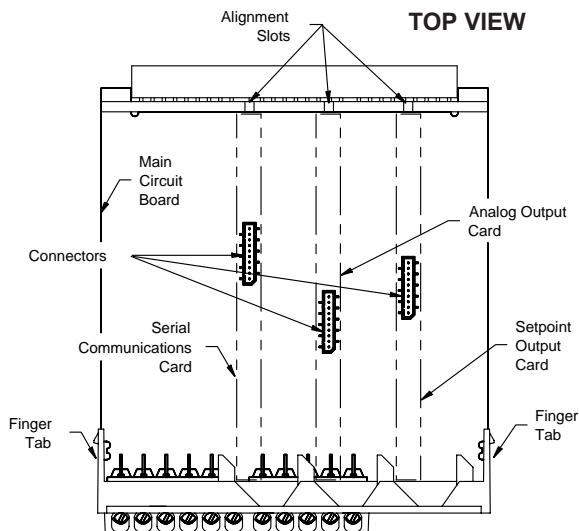

### To Install:

1. With the meter removed from the case, locate the plug-in card connector for the card type to be installed. The types are keyed by position with different main circuit board connector locations. When installing the card, hold the meter by the rear terminals and not by the front display board. If installing the Quad sourcing Plug-in Card (PAXCDS40), set the jumper for internal or external supply operation before continuing.

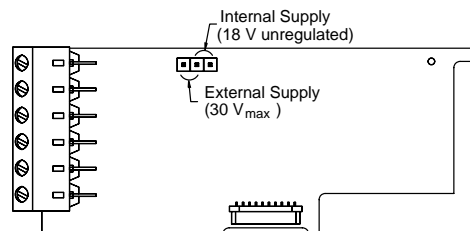

2. Install the plug-in card by aligning the card terminals with the slot bay in the rear cover. Be sure the connector is fully engaged and the tab on the plug-in card rests in the alignment slot on the display board.
3. Slide the meter base back into the case. Be sure the rear cover latches fully into the case.
4. Apply the plug-in card label to the bottom side of the meter in the designated area. Do Not Cover the vents on the top surface of the meter. The surface of the case must be clean for the label to adhere properly.

## 4.0 WIRING THE METER

### WIRING OVERVIEW

Electrical connections are made via screw-clamp terminals located on the back of the meter. All conductors should conform to the meter's voltage and current ratings. All cabling should conform to appropriate standards of good installation, local codes and regulations. It is recommended that the power supplied to the meter (DC or AC) be protected by a fuse or circuit breaker.

When wiring the meter, compare the numbers embossed on the back of the meter case against those shown in wiring drawings for proper wire position. Strip the wire, leaving approximately 0.3" (7.5 mm) bare lead exposed (stranded wires should be tinned with solder). Insert the lead under the correct screw-clamp terminal and tighten until the wire is secure (Pull wire to verify tightness). Each terminal can accept up to one #14 AWG (2.55 mm) wire, two #18 AWG (1.02 mm), or four #20 AWG (0.61 mm).

### EMC INSTALLATION GUIDELINES

Although this meter is designed with a high degree of immunity to Electro-Magnetic Interference (EMI), proper installation and wiring methods must be followed to ensure compatibility in each application. The type of the electrical noise, source or coupling method into the meter may be different for various installations. The meter becomes more immune to EMI with fewer I/O connections. Cable length, routing, and shield termination are very important and can mean the difference between a successful or troublesome installation. Listed below are some EMC guidelines for successful installation in an industrial environment.

1. The meter should be mounted in a metal enclosure, which is properly connected to protective earth.
2. Use shielded (screened) cables for all Signal and Control inputs. The shield (screen) pigtail connection should be made as short as possible. The connection point for the shield depends somewhat upon the application. Listed below are the recommended methods of connecting the shield, in order of their effectiveness.
  - a. Connect the shield only at the panel where the unit is mounted to earth ground (protective earth).
  - b. Connect the shield to earth ground at both ends of the cable, usually when

the noise source frequency is above 1 MHz.

- c. Connect the shield to common of the meter and leave the other end of the shield unconnected and insulated from earth ground.
3. Never run Signal or Control cables in the same conduit or raceway with AC power lines, conductors feeding motors, solenoids, SCR controls, and heaters, etc. The cables should be run in metal conduit that is properly grounded. This is especially useful in applications where cable runs are long and portable two-way radios are used in close proximity or if the installation is near a commercial radio transmitter.
  4. Signal or Control cables within an enclosure should be routed as far as possible from contactors, control relays, transformers, and other noisy components.
  5. In extremely high EMI environments, the use of external EMI suppression devices, such as ferrite suppression cores, is effective. Install them on Signal and Control cables as close to the unit as possible. Loop the cable through the core several times or use multiple cores on each cable for additional protection. Install line filters on the power input cable to the unit to suppress power line interference. Install them near the power entry point of the enclosure. The following EMI suppression devices (or equivalent) are recommended:

Ferrite Suppression Cores for signal and control cables:

Fair-Rite # 0443167251 (RLC# FCOR0000)

TDK # ZCAT3035-1330A

Steward # 28B2029-0A0

Line Filters for input power cables:

Schaffner # FN2010-1/07 (RLC# LFIL0000)

Schaffner # FN670-1.8/07

Corcom # 1 VR3

*Note: Reference manufacturer's instructions when installing a line filter.*

6. Long cable runs are more susceptible to EMI pickup than short cable runs. Therefore, keep cable runs as short as possible.
7. Switching of inductive loads produces high EMI. Use of snubbers across inductive loads suppresses EMI.  
Snubber: RLC# SNUB0000.

# 4.1 POWER WIRING

## AC Power

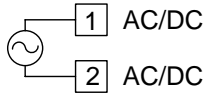

## DC Power

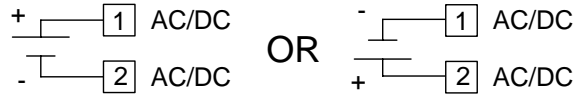

# 4.2 INPUT SIGNAL WIRING



**CAUTION:** Sensor input common is NOT isolated from user input common. In order to preserve the safety of the meter application, the sensor input common must be suitably isolated from hazardous live earth referenced voltage; or input common must be at protective earth ground potential. If not, hazardous voltage may be present at the User Inputs and User Input Common terminals. Appropriate considerations must then be given to the potential of the user input common with respect to earth ground; and the common of the isolated plug-in cards with respect to input common.

If you are wiring Input B, connect signal to Terminal 6 instead of 5, and set DIP switches 4, 5, and 6 to the positions shown for 1, 2, and 3.

<p><b>Magnetic Pickup</b></p>	<p><b>AC Inputs From Tach Generators, Etc.</b></p>	<p><b>Two Wire Proximity, Current Source</b></p>
<p><b>Current Sinking Output</b></p>	<p><b>Current Sourcing Output</b></p>	<p><b>Interfacing With TTL</b></p>
<p><b>Switch or Isolated Transistor; Current Sink</b></p>	<p><b>Switch or Isolated Transistor; Current Source</b></p>	<p><b>Emitter Follower; Current Source</b></p>
<p><b>Quad; Current Sink Output</b></p> <p>Single Counter A</p>	<p><b>Dual Quad/Count; Current Sink Output</b></p> <p>Counter A &amp; Rate B</p>	<p><b>Dual Quad/Quad; Current Sink Output</b></p> <p>Counter A &amp; Counter B</p>

Shaded areas not recommended for counting applications.

### 4.3 USER INPUT WIRING

If User Input 1 and/or 2 are wired for quadrature or directional counting, an additional switching device should not be connected to that User Input terminal. User Input terminal does not need to be wired in order to remain in inactive state.

#### Sinking Logic ( $USrREt Lo$ )

When the  $USrREt$  parameter is programmed to  $Lo$ , the user inputs of the meter are internally pulled up to +3.3 V with 20 K $\Omega$  resistance. The input is active when it is pulled low (<1.1 V).

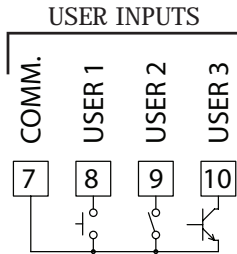

#### Sourcing Logic ( $USrREt Hi$ )

When the  $USrREt$  parameter is programmed to  $Hi$ , the user inputs of the meter are internally pulled down to 0 V with 20 K $\Omega$  resistance. The input is active when a voltage greater than 2.2 VDC is applied.

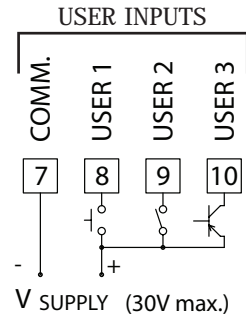

### 4.4 SETPOINT (ALARMS) WIRING

### 4.5 SERIAL COMMUNICATION WIRING

### 4.6 ANALOG OUTPUT WIRING

See appropriate plug-in card bulletin for wiring details.

### 4.7 PRESCALER OUTPUT WIRING (NPN O.C.)

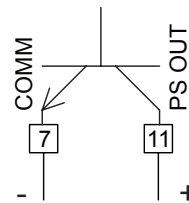

## 5.0 FRONT PANEL KEYS AND DISPLAY OVERVIEW

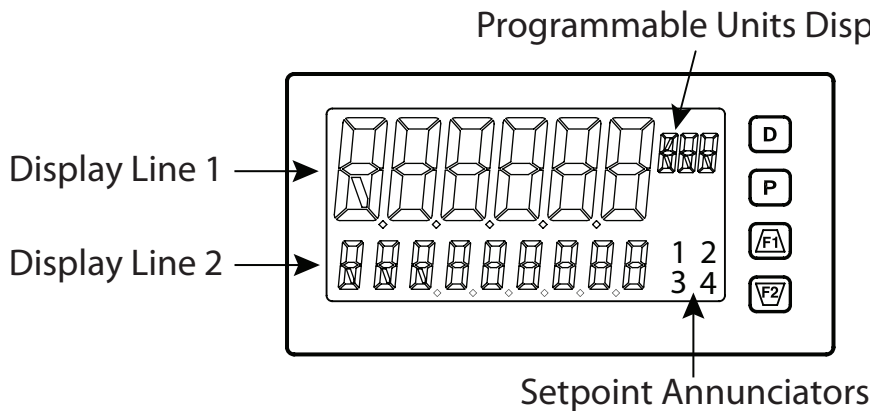

#### KEY DISPLAY MODE OPERATION

- D** Index through enabled Line 2 display values
- P** Enter full programming mode or access the parameter and hidden display loops
- F1** User programmable Function key 1; hold for 3 seconds for user programmable second function 1  
Index through enabled Line 1 values (factory setting)
- F2** User programmable Function key 2; hold for 3 seconds for user programmable second function 2  
No function (factory setting)

#### PROGRAMMING MODE OPERATION

- Return to the previous menu level (momentary press)  
Quick exit to Display Mode (press and hold)
- Access the programming parameter menus, store selected parameter and index to next parameter
- Increment selected parameter value
- Decrement selected parameter value

### DISPLAY LINE 1

Line 1 is the large, 6-digit top line display. Counter values, rate values and the maximum (Hi) and minimum (Lo) rate capture values can be shown on Line 1. The 3-digit Units mnemonic characters can be used to indicate which Line 1 display value is shown. Standard or custom mnemonics are available for the Line 1 values. See Line 1 parameters in the Display Parameters programming section for configuration details.

### DISPLAY LINE 2

Line 2 is the smaller, 9-digit bottom line display. Counter values, rate values, rate capture values, setpoint values and parameter List A/B status can all be shown on the Line 2 display. The display loops described below are used to view, reset and modify the selected display values, based on the Line 2 Value Access setting programmed for each available value. See Line 2 parameters in the Display Parameters programming section for configuration details.



# LINE 2 DISPLAY LOOPS

The PAX2D offers three display loops to allow users quick access to needed information.

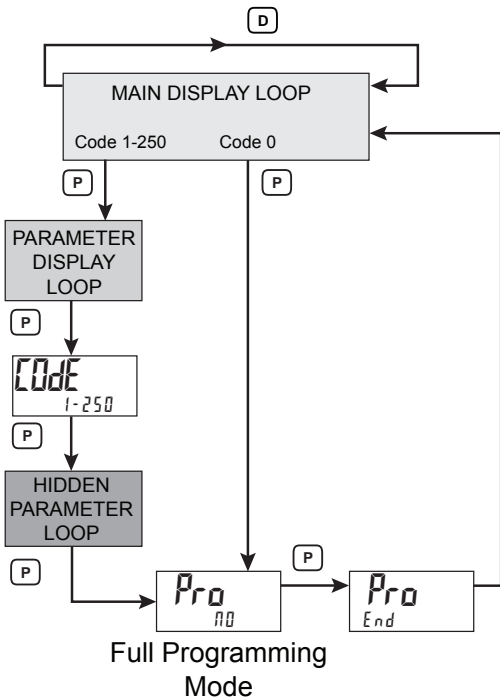

## Main Display Loop

In the Main Display Loop, the D key is pressed to sequence through the selected Line 2 values. A left justified 2 or 3-character mnemonic indicates which Line 2 value is currently shown. When in the Main Display Loop, the Function keys  $\overline{F1}$  and  $\overline{F2}$  perform the user functions programmed in the User Input parameter section.

## Parameter Display and Hidden Parameter Loops

These display loops provide quick access to selected parameters that can be viewed and modified on Line 2 without having to enter Full Programming mode. These values include Parameter List A/B selection, setpoints, scale factors, counter load values and display (color, intensity and contrast) settings. To utilize the Parameter Display or Hidden Parameter Loops, a security code (1-250) must be programmed. (See Programming Security Code in the Display Parameters programming section for details.)

The Parameter Display Loop is accessed by pressing the P key. The selected Parameter Display Loop values can be viewed and/or changed per the Line 2 Value Access setting programmed for each available value. The Hidden Parameter Loop follows the Parameter Display Loop, and can only be accessed when the correct security code is entered at the Code prompt. Combining the two parameter loops provides an area for parameters that require general access and/or protected or secure access depending on the application needs.

While in the Parameter Display and Hidden Parameter loops, pressing the D key will return the meter to the Main Display Loop. To directly access the Code prompt, press and hold the P key. This can be done from the Main Display Loop or at any point during the Parameter Display Loop. Also, to directly access Full Programming mode while in the Hidden Parameter Loop, press and hold the P key to bypass any remaining Hidden Parameter Loop values.

# 6.0 PROGRAMMING THE PAX2D

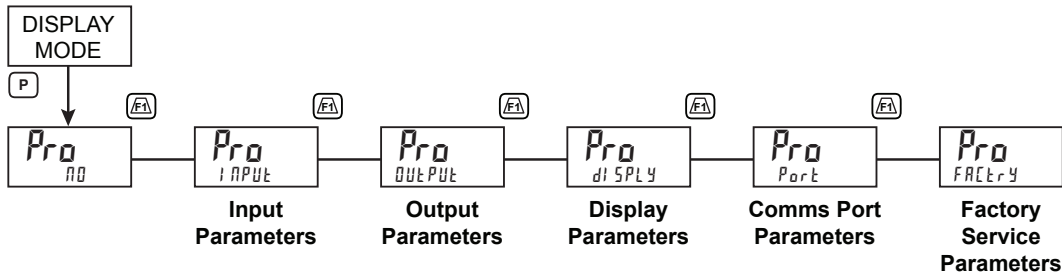

It is recommended that program settings be recorded as programming is performed. A blank Parameter Value Chart is provided at the end of this bulletin.

## PROGRAMMING MODE ENTRY

The Programming Mode is entered by pressing the P key. Full Programming Mode will be accessible unless the meter is programmed to use the Parameter Display Loop or Hidden Parameter Loop on the Line 2 display. In this case, programming access will be limited by a security code and/or a hardware program lock. (Refer to the previous section for details on Line 2 display loops and limited programming access.) Full Programming Mode permits all parameters to be viewed and modified. In this mode, the front panel keys change to Programming Mode Operations and certain user input functions are disabled.

## MODULE ENTRY

The Programming Menu is organized into five modules. These modules group together parameters that are related in function. The  $\overline{F1}$  and  $\overline{F2}$  keys are used to select the desired module. The displayed module is entered by pressing the P key.

## MODULE MENU

Upon entering a module, a parameter selection sub-menu is provided to choose the specific parameter type for programming. For example, this includes counter, rate and user input under the Input Parameter menu. Use the  $\overline{F1}$  and  $\overline{F2}$  keys to select the desired parameter type, and press the P key to enter the parameter menu.

## PARAMETER MENU

Upon entering the Parameter Menu, the P key is pressed to advance to a specific parameter to be changed. After completing the parameter menu, or upon pressing the D key, the display returns to the initial entry point for the parameter menu. For each additional press of the D key, the display returns to the previous level within the module until exiting the module entirely.

## SELECTION/VALUE ENTRY

For each parameter, the top line display shows the parameter while the bottom line shows the selections/value for that parameter. The  $\overline{F1}$  and  $\overline{F2}$  keys are used to move through the selections/values for the parameter. Pressing the P key, stores and activates the displayed selection/value. This also advances the meter to the next parameter.

## Numerical Value Entry

For numerical values, the value is displayed with one digit flashing (initially the right most digit). Pressing the  $\overline{F1}$  or  $\overline{F2}$  keys will increment or decrement the value from the point of the selected digit. If the key is pressed and held, the value automatically scrolls. The longer the key is held, the faster the value scrolls.

For large value changes, press and hold the  $\overline{F1}$  or  $\overline{F2}$  key. While pressing that key, momentarily press the D key and the value scrolls by 1000's as the arrow key is held. Releasing the arrow key removes the 1000's scroll feature. The arrow keys can then be used to make small value changes as described above.

As an alternative, a Select and Set value entry method is provided. This can be used in combination with the value scrolling described above. To change the selected digit in the numerical value, press both the  $\overline{F1}$  and  $\overline{F2}$  keys

simultaneously. The next digit to the left will be selected (flashing). If both keys are pressed and held, the selected digit will scroll from right to left until one or both keys are released.

Once a digit is selected, the arrow keys are used to increment or decrement that digit to the desired number.

## PROGRAMMING MODE EXIT

To exit the Programming Mode, press and hold the **D** key (from anywhere in the Programming Mode) or press the **P** key with *PrO AB* displayed. This will commit any stored parameter changes to memory and return the meter to the Display Mode. If a parameter was just changed, the **P** key must be pressed to store the change before pressing the **D** key. (If power loss occurs before returning to the Display Mode, verify recent parameter changes.)

## PROGRAMMING TIPS

It is recommended to start with the Input Parameters and proceed through each module in sequence. If lost or confused while programming, press and hold the **D** key to exit programming mode and start over. When programming is complete, it is recommended to record the meter settings on the Parameter Value Chart in the back of the bulletin and lock out programming with a user input or lock-out code.

Factory Settings may be completely restored in the Factory Service Operations module. This is useful when encountering programming problems.

# INPUT PARAMETERS (INPUT)

## INPUT SELECT



COUNT RATE USER

Select the Count, Rate or User Input to be programmed.

## COUNTER INPUT PARAMETERS (COUNT)

This section details the programming for Counter A and the Prescaler Output, Counter B, and Counter C. For maximum input frequency, the counters not being used should be set to mode *ABNE*. The Prescaler should be set to *AB* when it is not in use. When set to *ABNE* or *AB*, the remaining related parameters are not accessible. A Select Parameter List feature for Scale Factors and Count Load values is explained in the User Input programming section.

In the display depictions shown in this section, "x" represents A, B, or C for the counter being programmed.

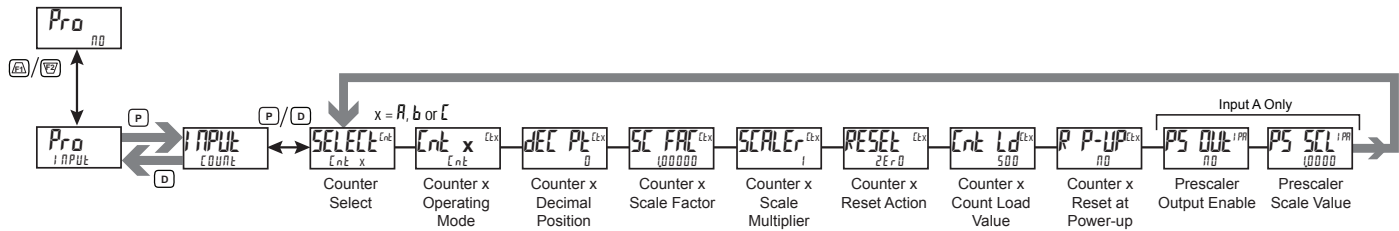

## COUNTER SELECT



CNT A CNT B CNT C

Select the Counter to be programmed.

## COUNTER OPERATING MODE

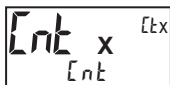

Choose the operating mode for the selected counter.

### Counter A Selections

SELECTION	MODE	DESCRIPTION
<i>ABNE</i>	None	Does not count.
<i>CNT</i>	Count X1	Adds Input A falling edge.
<i>CNTUD</i>	Count X1 w/direction	Adds Input A falling edge if Input B is high. Subtracts Input A falling edge if Input B is low.
<i>dCNTUD</i>	Dual Count X1 w/direction	Adds Input A falling edge if User 1 is high. Subtracts Input A falling edge if User 1 is low.
<i>AdARd</i>	Dual Input X1 Add/Add	Adds Input A falling edge and Input B falling edge.
<i>AdASub</i>	Dual Input X1 Add/Subtract	Adds Input A falling edge. Subtracts Input B falling edge.
<i>qURd 1</i>	Quad X1	Adds Input A rising edge when Input B is high. Subtracts Input A falling edge when Input B is high

SELECTION	MODE	DESCRIPTION
<i>qURd 2</i>	Quad X2	Adds Input A rising edge when Input B is high and Input A falling edge when Input B is low. Subtracts Input A falling edge when Input B is high and Input A rising edge when Input B is low.
<i>qURd 4</i>	Quad X4	Adds Input A rising edge when Input B is high, Input A falling edge when Input B is low, Input B rising edge when Input A is low, and Input B falling edge when Input A is high. Subtracts Input A falling edge when Input B is high, Input A rising edge when Input B is low, Input B rising edge when Input A is high, and Input B falling edge when Input A is low.
<i>dqURd 1</i>	Dual Count Quad X1	Adds Input A rising edge when User 1 is high. Subtracts Input A falling edge when User 1 is high.
<i>dqURd 2</i>	Dual Count Quad X2	Adds Input A rising edge when User 1 is high and Input A falling edge when User 1 is low. Subtracts Input A falling edge when User 1 is high and Input A rising edge when User 1 is low.
<i>CNT 2</i>	Count X2	Adds Input A rising and falling edges.
<i>CNTUD 2</i>	Count X2 w/direction	Adds Input A rising and falling edges if Input B is high. Subtracts Input A rising and falling edge if Input B is low.
<i>dCNTUD 2</i>	Dual Count X2 w/direction	Adds Input A rising and falling edges if User 1 is high. Subtracts Input A rising and falling edge if User 1 is low.

### Counter B Selections

SELECTION	MODE	DESCRIPTION
<i>None</i>	None	Does not count.
<i>Batch</i>	Batch	Counter B internally counts the number of output activations of the selected setpoint(s). The count source is selected in the Yes/No sub-menu shown for each setpoint ( <i>Batch 51</i> thru <i>Batch 54</i> ).
<i>Count X1</i>	Count X1	Adds Input B falling edge.
<i>Dual Count X1 w/direction</i>	Dual Count X1 w/direction	Adds Input B falling edge if User 2 is high. Subtracts Input B falling edge if User 2 is low.
<i>Dual Count Quad X1</i>	Dual Count Quad X1	Adds Input B rising edge when User 2 is high. Subtracts Input B falling edge when User 2 is high.
<i>Dual Count Quad X2</i>	Dual Count Quad X2	Adds Input B rising edge when User 2 is high and Input B falling edge when User 2 is low. Subtracts Input B falling edge when User 2 is high and Input B rising edge when User 2 is low.
<i>Count X2</i>	Count X2	Adds Input B rising and falling edges.
<i>Dual Count X2 w/direction</i>	Dual Count X2 w/direction	Adds Input B rising and falling edges if User 2 is high. Subtracts Input B rising and falling edge if User 2 is low.

### Counter C Selections

SELECTION	MODE	DESCRIPTION
<i>None</i>	None	Does not count.
<i>Counter A</i>	Counter A	Counter C counts the incoming pulses from Counter A input as per Counter A mode of operation. The signal is scaled only according to Counter C parameters.
<i>Counter B</i>	Counter B	Counter C counts the incoming pulses from Counter B input as per Counter B mode of operation. The signal is scaled only according to Counter C parameters.
<i>Counter A + Counter B</i>	Counter A + Counter B	Counter C counts the incoming pulses from Counter A and B inputs as per Counter A and B modes of operation. The result is scaled only according to Counter C parameters. (Example: If Counter A is set for Count X1 mode and Counter B is set for Count X2 mode, then Counter C will increment by 1 for each pulse received on Input A and increment by 2 for each pulse received on Input B less any effects of scaling.)
<i>Counter A - Counter B</i>	Counter A - Counter B	Counter C counts the incoming pulses from Counter A and B inputs as per Counter A and B modes of operation and subtracts the B counts from the A counts. The result is scaled only according to Counter C parameters. (Example: If Counter A is set for Count X1 mode and Counter B is set for Count X2 mode, then Counter C will increment by 1 for each pulse received on Input A and decrement by 2 for each pulse received on Input B less any effects of scaling.)

Note: Counter A, B and C must all be reset at the same time for the math to be performed on the display values.

<i>Batch</i>	Batch	Counter C internally counts the number of output activations of the selected setpoint(s). The count source is selected in the Yes/No sub-menu shown for each setpoint ( <i>Batch 51</i> thru <i>Batch 54</i> ).
<i>Slave</i>	Slave	Counter C functions as a serial slave display. See Serial Communications section for details.

### COUNTER DECIMAL POSITION



0 0.00 0.0000  
0.0 0.000 0.00000

This selects the decimal point position for the selected counter, and any setpoint value assigned to that counter. The selection will also affect that counter's scale factor calculations.

### COUNTER SCALE FACTOR



0.00001 to 9.99999

The number of input counts for the selected counter is multiplied by the scale factor and the scale multiplier to obtain the desired process value. A scale factor of 1.00000 will result in the display of the actual number of input counts. (Details on scaling calculations are explained at the end of this section.) Scale Factor values can also be entered during Program Lockout, if enabled in the Parameter Display loop. See "Line 2 Display Access" in the Display Parameter Module.

### COUNTER SCALE MULTIPLIER



10 1 0.1 0.01

The number of input counts for the selected counter is multiplied by the scale multiplier and the scale factor to obtain the desired process value. (Details on scaling calculations are explained at the end of this section.)

### COUNTER RESET ACTION



Zero Count Load

When the selected counter is reset, it returns to zero or the counter count load value. This reset action applies to all selected counter resets, except a setpoint generated counter auto reset programmed in the Setpoint Output Parameter Module.

### COUNTER COUNT LOAD VALUE



- 199999 to 999999

When Reset to Count Load action is chosen, the selected counter will reset to this value. Count Load values can also be entered during Program Lockout, if enabled in the Parameter Display loop. See "Line 2 Display Access" in the Display Parameter Module.

### COUNTER RESET AT POWER-UP



NO YES

The selected counter may be programmed to reset at each meter power-up.



The next two parameters will only appear when programming Counter A.

### PRESCALER OUTPUT ENABLE



NO YES

This enables the prescaler output. The prescaler output is useful for providing a lower frequency scaled pulse train to a PLC or another external counter. On each falling edge of Input A, the prescaler output register increments by the prescaler scale value (*PS SCL*). When the register equals or exceeds 1.0000, a pulse is output and the register is lowered by 1.0000. The prescaler register is reset to zero whenever Counter A is reset (except for Setpoint Counter Auto Reset). (See Prescaler Output Figure.)

### PRESCALER SCALE VALUE



0.0001 to 1.0000

The prescaler output frequency is the Input A frequency times the prescaler scale value.

### PRESCALER OUTPUT FIGURE

Prescaler Output Value = 0.25

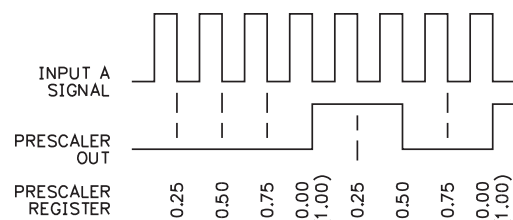

## SCALING CALCULATION

Each counter has the ability to scale an input signal to a desired display value. This is accomplished by the counter mode ( $Cnt\ x$ ), decimal point ( $dEC\ PL$ ), scale factor ( $SC\ FRS$ ), and scale multiplier ( $SCALEr$ ). The scale factor is calculated using:

$$SF (SC\ FRS) = \frac{DDD}{(\text{Number of pulses per 'single' unit} \times CMF \times SM)}$$

### Where:

**Number of pulses per 'single' unit:** pulses per unit generated by the process (i.e. # of pulses per foot)

**CMF:** Counter Mode ( $Cnt\ x$ ) times factor of the mode 1, 2 or 4.

**SM:** Scale Multiplier ( $SCALEr$ ) selection of 10, 1, 0.1 or 0.01.

**DDD:** Desired Display Decimal (1 = 1, 1.0 = 10, 1.00 = 100, etc.)

### Example:

- Indicate feet to the hundredths (0.00) with 100 pulses per foot:  
Scale Factor would be  $100 / (100 \times 1 \times 1) = 1$   
(In this case, the scale multiplier and counter mode factor are 1)
- Indicate feet with 120 pulses per foot: Scale Factor would be  $1 / (120 \times 1 \times 1) = 0.0083333$ . (In this case, the scale multiplier of 0.01 could be used:  $1 / (120 \times 1 \times 0.01) = 0.83333$  or show to hundredths (0.00):  $100 / (120 \times 1 \times 1) = 0.8333$ .)

## General Rules on Scaling

- It is recommended that, the scale factor be as close as possible to, but not exceeding 1.00000. This can be accomplished by increasing or decreasing the counter decimal point position, using the scale multiplier, or selecting a different count mode.
- To double the number of pulses per unit, use counter modes direction X2 or quad X2. To increase it by four times, use counter mode quad X4. Using these modes will decrease the allowable maximum input frequency.
- A scale factor greater than 1.00000 will cause Counter display rounding. In this case, digit jumps could be caused by the internal count register rounding the display. The precision of a counter application cannot be improved by using a scale factor greater than 1.00000.
- The number of pulses per single unit must be greater than or equal to the DDD value in order for the scale factor to be less than or equal to one.
- Lowering the scale factor can be accomplished by lowering the counter decimal position. (Example: 100 (Hundredths)/10 pulses = 10.000 lowering to 10 (Tenths)/10 = 1.000.)

## RATE INPUT PARAMETERS (RATE)

This section details programming for the Rate indicators (A, B and C) and the Maximum and Minimum Rate Capture displays. For maximum input frequency, the Rate indicators should be disabled when they are not in use. When Rate Enable (Rate A and B) or Rate Calculation (Rate C) is set to  $NO$  or  $NOAE$ , the remaining related parameters are not accessible. In the display depictions shown in this section, "x" represents A or B for the rate indicator being programmed.

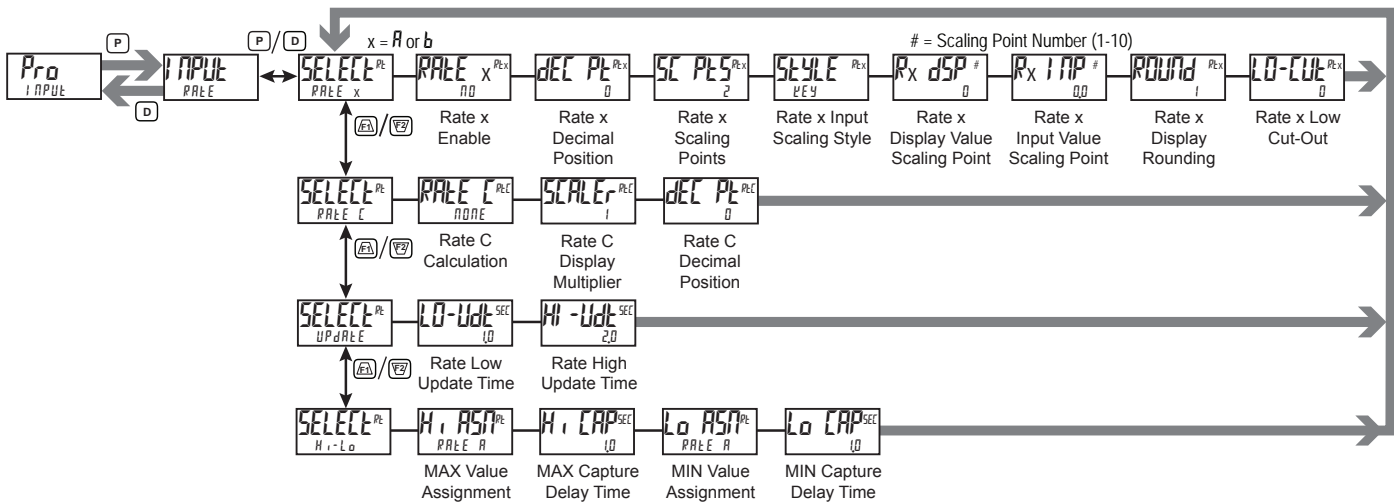

### RATE SELECTION



RATE A    RATE C    Hi-Lo  
RATE b    UPDATE

Select the Rate parameters to be programmed.

### RATE ENABLE



NO    YES

Select YES to measure the rate (speed) of pulses on the corresponding Input. Rate measurement is independent of the corresponding Counter count modes.

### RATE DECIMAL POSITION



0    0.00    0.0000  
0.0    0.000

This selects the decimal point position for the selected Rate indicator.

### RATE SCALING POINTS

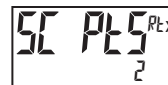

2 to 10

This parameter sets the number of scaling points for the Rate Scaling function. The number of scaling points used depends on the linearity of the process and the display accuracy required.

### About Scaling Points

Each scaling point is specified by two programmable parameters: A desired Rate Display Value ( $Rx\ DSP$ ) and a corresponding Rate Input Value ( $Rx\ INP$ ). Scaling points are entered sequentially in ascending order of Rate Input value. Each scaling point defines the upper endpoint of a linear segment, with the lower endpoint being the previous scaling point.

### Linear Application – 2 Scaling Points

Linear processes use two scaling points to provide a linear Rate display from 0 up to the maximum input frequency. For typical zero based frequency measurements, the lower point is set to display 0 for 0 Hz input (factory setting) and the upper point set to display the desired value for a given input frequency. For non-zero based applications, the lower point is set to the desired display for 0 Hz input.

## Non-linear Application – Up to 10 Scaling Points

For non-linear processes, up to 10 scaling points may be used to provide a piece-wise linear approximation representing the non-linear function. The Rate Display will be linear between sequential scaling points. Thus, the greater the number of scaling points, the greater the conformity accuracy. The Crimson software provides several linearization equations for common Rate applications.

### RATE INPUT SCALING STYLE



KEY APPLY

Rate Input values for scaling points can be entered by using the Key-in or the Applied style described below.

#### Key-in:

Enter the Rate Input value by pressing the  $\boxed{F1}$  or  $\boxed{F2}$  keys. This value is always in pulses per second (Hz).

#### Applied:

The existing programmed Rate Input value will appear. To retain this value, press the **P** key to continue to the next parameter. To enter a new value, apply an external rate signal to the appropriate input terminal. Press the  $\boxed{F2}$  key and the applied input frequency (in Hz) will be displayed. To insure the correct reading, wait until a consistent reading is displayed, then press the **P** key to accept this value as the Rate Input Value and continue to the next parameter. Follow the same procedure if using more than 2 scaling points.

### RATE DISPLAY VALUE SCALING POINT 1



0 to 999999

For all zero-based applications (display value 0 for 0 Hz input), the Display Value and Input Value for Scaling Point 1 should be set to 0 and 0.0 respectively. For non-zero based applications, enter the desired Display Value for a 0 Hz input.

### RATE INPUT VALUE SCALING POINT 1



0.0 to 99999.9

Normally the Rate Input Value for Scaling Point 1 is 0.0.

### RATE DISPLAY VALUE SCALING POINT 2



0 to 999999

Enter the desired Rate Display Value for Scaling Point 2.

### RATE INPUT VALUE SCALING POINT 2



0.0 to 99999.9

Enter the corresponding Rate Input Value for Scaling Point 2, by using the Input Scaling Style selected.

### RATE DISPLAY ROUNDING



1 5 20 100  
2 10 50

Rounding values other than '1' round the Rate display to the nearest increment selected (e.g. rounding of '5' causes 122 to round to 120 and 123 to round to 125). Rounding starts at the least significant digit of the Rate display.

## RATE LOW CUT-OUT



0 to 999999

The Low Cut Out value forces the Rate display to zero when the Rate display falls below the value entered.

## RATE SCALING

To scale the Rate, enter a Scaling Display value with a corresponding Scaling Input value. (The Display and Input values can be entered by Key-in or Applied Methods.) These values are internally plotted to a Display value of 0 and Input value of 0 Hz. A linear relationship is formed between these points to yield a rate display value that corresponds to the incoming input signal rate.

## KEY-IN SCALING METHOD CALCULATION

If a display value versus input signal (in pulses per second) is known, then those values can be entered into Scaling Display ( $R_x dSP$ ) and Scaling Input ( $R_x INP$ ). No further calculations are needed.

If only the number of pulses per 'single' unit (i.e. # of pulses per foot) is known, then it can be entered as the Scaling Input value and the Scaling Display value will be entered as the following:

RATE PER	DISPLAY ( $R_x dSP$ )	INPUT ( $R_x INP$ )
Second	1	# of pulses per unit
Minute	60	# of pulses per unit
Hour	3600	# of pulses per unit

### NOTES:

- If # of pulse per unit is less than 10, then multiply both Input and Display values by 10.
- If # of pulse per unit is less than 1, then multiply both Input and Display values by 100.
- If the Display value is raised or lowered, then Input value must be raised or lowered by the same proportion (i.e. Display value for per hour is entered by a third less (1200) then Input value is a third less of # of pulses per unit). The same is true if the Input value is raised or lowered, then Display value must be raised or lowered by the same proportion.

### EXAMPLE:

- With 15.1 pulses per foot, indicate feet per minute in tenths. Scaling Display = 60.0 Scaling Input = 15.1.
- With 0.25 pulses per gallon, indicate whole gallons per hour. (To have greater accuracy, multiply both Input and Display values by 10.) Scaling Display = 36000 Scaling Input = 2.5.

## RATE C PARAMETERS



## RATE C CALCULATION



Select the calculation for the Rate C display.

SELECTION	MODE	DESCRIPTION
NONE	None	Rate C disabled.
Add A/B	SUM (A+B)	Rate C shows the sum of Rate A and Rate B.
Sub A/B	DIFFERENCE (A-B)	Rate C shows the difference of Rate A and Rate B.
Pct A/B	RATIO (A/B)	Rate C shows the percentage of Rate A to Rate B.
Pct A/E	PERCENT OF TOTAL (A/A+B)	Rate C shows the percentage of Rate A to the total of Rate A and Rate B.
Pct dr	PERCENT DRAW (A-B/B)	Rate C shows the percent draw between Rate A and Rate B.

### RATE C DISPLAY MULTIPLIER



Set the Display Multiplier to obtain the desired Rate C display resolution. For Rate C percentage calculations, the result is internally multiplied by 100 to show percent as a whole number. By using a Display Multiplier of 10, 100 or 1000, along with the proper decimal point position, percentage can be shown in tenths, hundredths or thousandths respectively.

### RATE C DECIMAL POSITION



Select the decimal point position for Rate C.

### RATE UPDATE PARAMETERS



#### RATE LOW UPDATE TIME (DISPLAY UPDATE)

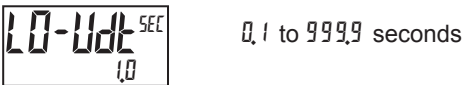

The Low Update Time is the minimum amount of time between display updates for all enabled Rate displays. Small Low Update Time values may increase the possibility of the display indicating an unstable input (jittery display). The factory setting of 1.0 will update the display at a minimum of every second.

#### RATE HIGH UPDATE TIME



The High Update Time is the maximum amount of time before the enabled Rate displays are forced to zero. (For more explanation, refer to Input Frequency Calculation.) The High Update Time must be higher than the Low Update Time and higher than the desired slowest readable speed (one divided by pulses per second). The factory setting of 2.0, will force the display to zero for speeds below 0.5 Hz or a pulse every 2 seconds.

### INPUT FREQUENCY CALCULATION

The meter determines the input frequency by summing the number of falling edges received during a sample period of time. The sample period begins on the first falling edge. At this falling edge, the meter starts accumulating time towards Low Update and High Update values. Also, the meter starts accumulating the number of falling edges. When the time reaches the Low Update Time value, the meter looks for one more falling edge to end the sample period. If a falling edge occurs (before the High Update Time value is reached), the Rate display will update to the new value and the next sample period will start on the same edge. If the High Update Time value is reached (without receiving a falling edge after reaching Low Update Time), then the sample period will end but the Rate display will be forced to zero. The High Update Time value must be greater than the Low Update Time value. Both values must be greater than 0.0. The input frequency calculated during the sample period, is then shown as a Rate value determined by either scaling method.

#### RATE VALUE CALCULATED

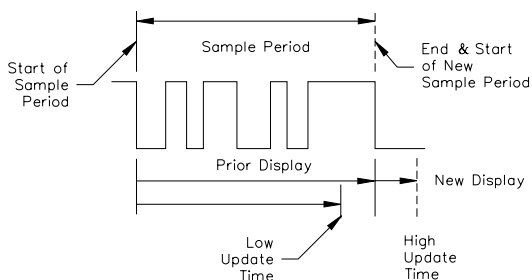

#### ZERO RATE CALCULATED

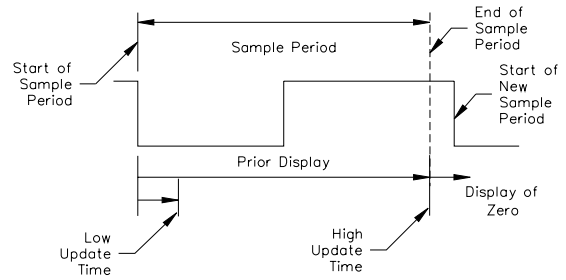

### RATE MAXIMUM/MINIMUM CAPTURE PARAMETERS



#### MAXIMUM CAPTURE VALUE ASSIGNMENT



Select the Rate display to which the Maximum Capture value is assigned.

#### MAXIMUM CAPTURE DELAY TIME



When the assigned Rate value is above the present Maximum rate value for the entered amount of time, the meter will capture that Rate value as the new Maximum value. A delay time helps to avoid false captures of sudden short spikes.

#### MINIMUM CAPTURE VALUE ASSIGNMENT



Select the Rate display to which the Minimum Capture value is assigned.

#### MINIMUM CAPTURE DELAY TIME



When the assigned Rate value is below the present Minimum rate value for the entered amount of time, the meter will capture that Rate value as the new Minimum value. A delay time helps to avoid false captures of sudden short spikes.

## USER INPUT/FUNCTION KEY PARAMETERS (USER)

This section details the programming for the rear terminal User Inputs and front panel Function Keys. Three user inputs are individually programmable to perform specific meter control functions. While in the Display Mode, the function is executed when the user input transitions to the active state. (Refer to the user input specifications for active state response times.) Certain User input functions are disabled in Programming Mode. Two front panel function keys,  $F1$  and  $F2$ , are also individually programmable to perform specific meter control functions. While in the Display Mode, the primary function is executed when the key is pressed. Holding the  $F1$  and  $F2$  function keys for three seconds executes a secondary function. It is possible to program a secondary function without a primary function. The front panel key functions are disabled in Programming Mode.

In most cases, if more than one user input and/or function key is programmed for the same function, the maintained (level trigger) actions will be performed while at least one of those user inputs or function keys are activated. The momentary (edge trigger) actions are performed every time any of those user inputs or function keys transition to the active state.

Some of the user functions have a value assignment sublist, which appears when the **P** key is pressed at the listed function. The function will only be performed for the assignment values entered as **YES**. If a user input or function key is configured for a function with a sublist, then that sublist will need to be scrolled through each time to access the remaining user inputs or function keys following the sublist.

In the parameter explanations,  $USER-n$  will represent all user inputs.  $F_n$  will represent both function keys and second function keys.

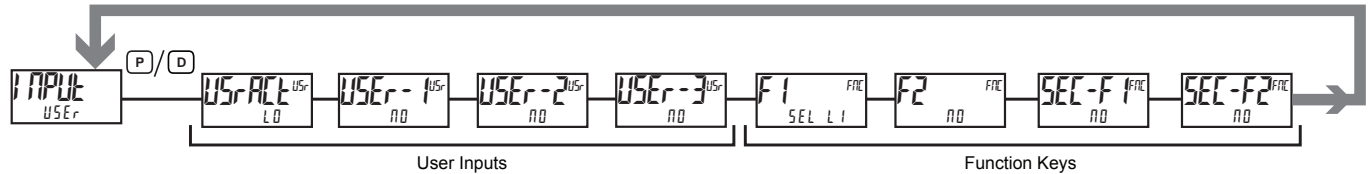

### USER INPUT ACTIVE STATE



LO HI

Select the desired active state for the User Inputs. Select **LO** for sink input, active low. Select **HI** for source input, active high.

### NO FUNCTION



No function is performed if activated. This is the factory setting for all user inputs and function key  $F2$ .

### PROGRAMMING MODE LOCK-OUT



Programming Mode is locked-out, as long as activated (maintained action). A security code can be configured to allow programming access during lock-out. This parameter is not available for the front panel function keys.

### SELECT LINE 1 DISPLAY



When activated (momentary action), selects the next enabled Line 1 Display value. This is the factory setting for function key  $F1$ .

### SELECT LINE 2 DISPLAY



When activated (momentary action), selects the next Line 2 Display value that is enabled in the Display loop.

### RESET LINE 1 DISPLAY



When activated (momentary action), resets the current Line 1 Display value.

### RESET LINE 2 DISPLAY

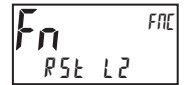

When activated (momentary action), resets the current Line 2 Display value.

### RESET LINE 1 AND LINE 2 DISPLAYS

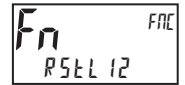

When activated (momentary action), resets both the current Line 1 Display value and Line 2 Display value.

### CHANGE DISPLAY COLOR



When activated (momentary action), Line 1 will change color green to red, red to orange, orange to green.

### ADJUST DISPLAY INTENSITY LEVEL

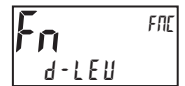

When activated (momentary action), the display intensity changes to the next intensity level.

### ADJUST DISPLAY CONTRAST LEVEL



When activated (momentary action), the display contrast changes to the next higher level.

### TURN OFF METER DISPLAY



Turns off the display backlight when activated. If a user input is used, the backlight is off when the user input is active (maintained action). If a front panel key is used, the backlight will toggle for each key press (momentary action). The backlight is always on in programming mode.

## SELECT PARAMETER LIST

Two lists of values are available for the Setpoints, Scale Factors, Counter Load values and Units mnemonics. The two lists are List A and List B. If a user input is used to select the list then List A is selected when the user input is not active and List B is selected when the user input is active (maintained action). If a front panel key is used to select the list then the list will toggle for each key press (momentary action). The display will only indicate which list is active when the list is changed.

A submenu is used to select whether the programmed Units Mnemonics are included in the List function. Select *YES* in the submenu to have different Units Mnemonics for List A and List B. Select *NO* to display the same mnemonics regardless of the list selected.

To program the values for List A and List B, first complete the programming of all the parameters with List A selected. Exit programming and switch to List B. Re-enter programming and program the desired values for the parameters included in the List.

DISPLAY	DESCRIPTION	FACTORY
<i>UNITS</i>	Units Mnemonics	<i>NO</i>

## PRINT REQUEST

The meter issues a block print through the serial port when activated. This selection will only function when the serial type parameter (*TYPE*) is set to Red Lion protocol (*rLE*). The serial protocol and the data transmitted during a print request is programmed in the Port menu section (*Port*).

If the user input is still active after the transmission is complete (about 100 msec), an additional transmission occurs. As long as the user input is held active, continuous transmissions occur. If assigned to a function key, only one transmission will take place with each key press.

## PRINT REQUEST AND RESET DISPLAYS

The meter issues a block print through the serial port when activated just like the Print Request function. In addition, when activated (momentary action), the meter performs a reset of the displays configured as *YES* in the sublist. Both the Print and Reset actions will only function when the serial type parameter (*TYPE*) is set to Red Lion protocol (*rLE*).

DISPLAY	DESCRIPTION	FACTORY
<i>Cnt A</i>	Counter A	<i>NO</i>
<i>Cnt B</i>	Counter B	<i>NO</i>
<i>Cnt C</i>	Counter C	<i>NO</i>
<i>Hi</i>	Maximum	<i>NO</i>
<i>Lo</i>	Minimum	<i>NO</i>

## MAINTAINED (LEVEL) RESET AND INHIBIT

The meter performs a reset and inhibits the displays configured as *YES* in the sublist, as long as activated (maintained action).

DISPLAY	DESCRIPTION	FACTORY
<i>Cnt A</i>	Counter A	<i>NO</i>
<i>Cnt B</i>	Counter B	<i>NO</i>
<i>Cnt C</i>	Counter C	<i>NO</i>
<i>Hi</i>	Maximum	<i>NO</i>
<i>Lo</i>	Minimum	<i>NO</i>

## MOMENTARY (EDGE) RESET

When activated (momentary action), the meter resets the displays configured as *YES* in the sublist.

DISPLAY	DESCRIPTION	FACTORY
<i>Cnt A</i>	Counter A	<i>NO</i>
<i>Cnt B</i>	Counter B	<i>NO</i>
<i>Cnt C</i>	Counter C	<i>NO</i>
<i>Hi</i>	Maximum	<i>NO</i>
<i>Lo</i>	Minimum	<i>NO</i>

## INHIBIT

The meter inhibits the displays configured as *YES* in the sublist, as long as activated (maintained action).

DISPLAY	DESCRIPTION	FACTORY
<i>Cnt A</i>	Counter A	<i>NO</i>
<i>Cnt B</i>	Counter B	<i>NO</i>
<i>Cnt C</i>	Counter C	<i>NO</i>
<i>Hi</i>	Maximum	<i>NO</i>
<i>Lo</i>	Minimum	<i>NO</i>

## STORE DISPLAY

The meter holds (freezes) the displays configured as *YES* in the sublist, as long as activated (maintained action). Internally, the counters and max and min values continue to update.

DISPLAY	DESCRIPTION	FACTORY
<i>Cnt A</i>	Counter A	<i>NO</i>
<i>Cnt B</i>	Counter B	<i>NO</i>
<i>Cnt C</i>	Counter C	<i>NO</i>
<i>Hi</i>	Maximum	<i>NO</i>
<i>Lo</i>	Minimum	<i>NO</i>

## STORE AND RESET DISPLAY

The meter holds (freezes) the displays and then performs a reset of the displays configured as *YES* in the sublist, as long as activated (maintained action).

DISPLAY	DESCRIPTION	FACTORY
<i>Cnt A</i>	Counter A	<i>NO</i>
<i>Cnt B</i>	Counter B	<i>NO</i>
<i>Cnt C</i>	Counter C	<i>NO</i>
<i>Hi</i>	Maximum	<i>NO</i>
<i>Lo</i>	Minimum	<i>NO</i>

## SETPOINT DEACTIVATE (RESET) MAINTAINED (LEVEL)

The meter deactivates (resets) the setpoint outputs configured as *YES* in the sublist, as long as activated (maintained action).

DISPLAY	DESCRIPTION	FACTORY
<i>S1</i>	Setpoint 1	<i>NO</i>
<i>S2</i>	Setpoint 2	<i>NO</i>
<i>S3</i>	Setpoint 3	<i>NO</i>
<i>S4</i>	Setpoint 4	<i>NO</i>



### SETPOINT DEACTIVATE (RESET) MOMENTARY (EDGE)

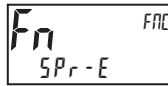

When activated (momentary action), the meter deactivates (resets) the setpoint outputs configured as YES in the sublist.

DISPLAY	DESCRIPTION	FACTORY
51	Setpoint 1	NO
52	Setpoint 2	NO
53	Setpoint 3	NO
54	Setpoint 4	NO

### SETPOINT ACTIVATE (SET) MOMENTARY (EDGE)



When activated (momentary action), the meter activates (sets) the setpoint outputs configured as YES in the sublist.

DISPLAY	DESCRIPTION	FACTORY
51	Setpoint 1	NO
52	Setpoint 2	NO
53	Setpoint 3	NO
54	Setpoint 4	NO

### SETPOINT ACTIVATE (SET) MAINTAINED (LEVEL)



The meter activates (sets) the setpoint outputs configured as YES in the sublist, as long as activated (maintained action).

DISPLAY	DESCRIPTION	FACTORY
51	Setpoint 1	NO
52	Setpoint 2	NO
53	Setpoint 3	NO
54	Setpoint 4	NO

### HOLD SETPOINT STATE



The meter holds the state of the setpoint outputs configured as YES in the sublist, as long as activated (maintained action).

DISPLAY	DESCRIPTION	FACTORY
51	Setpoint 1	NO
52	Setpoint 2	NO
53	Setpoint 3	NO
54	Setpoint 4	NO

## OUTPUT PARAMETERS (OUTPUT)

### OUTPUT SELECT



SETPNT ANALOG

Select the Setpoint or Analog output to be programmed. The Analog output selection only appears if an analog output plug-in card is installed in the meter.

### SETPOINT OUTPUT PARAMETERS (SETPNT)

This section details programming for the Setpoint (alarm) outputs. To have setpoint outputs, a setpoint Plug-in card needs to be installed into the PAX2D (see Ordering Information). Depending on the card installed, there will be two or four setpoint outputs available. For maximum input frequency, unused setpoints should be configured for NO action. A Select Parameter List feature for setpoint values is explained in User Input/Function Key Parameters.

The Setpoint Assignment and Setpoint Output Action determine certain setpoint feature availability. The Setpoint Parameter Availability chart illustrates this.

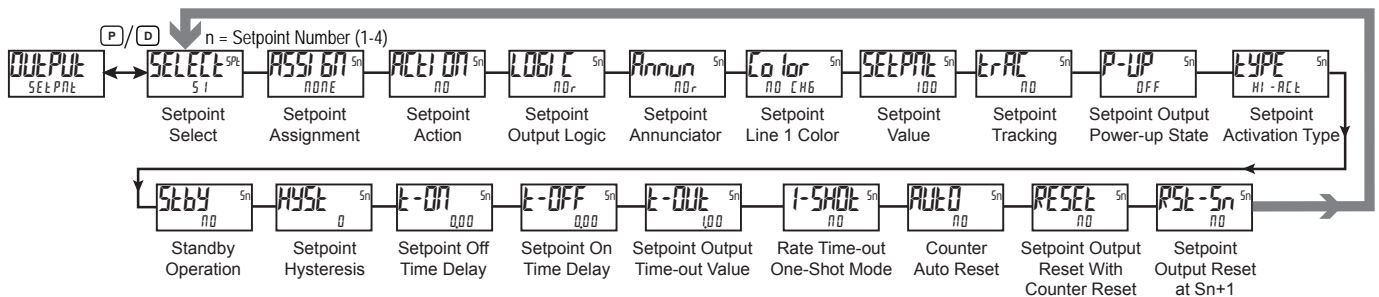

### SETPOINT PARAMETER AVAILABILITY

PARAMETER	DESCRIPTION	COUNTER ASSIGNMENT			RATE ASSIGNMENT		
		TIMED OUT E-OUT	BOUNDARY BOUND	LATCH LATCH	TIMED OUT E-OUT	BOUNDARY BOUND	LATCH LATCH
LOGIC	Setpoint Output Logic	Yes	Yes	Yes	Yes	Yes	Yes
ANNUN	Setpoint Annunciator	Yes	Yes	Yes	Yes	Yes	Yes
COLOR	Setpoint Line 1 Color	Yes	Yes	Yes	Yes	Yes	Yes
SETPNT	Setpoint Value	Yes	Yes	Yes	Yes	Yes	Yes
TRAC	Setpoint Tracking	Yes	Yes	Yes	Yes	Yes	Yes
P-UP	Setpoint Output Power-up State	Yes	Yes	Yes	Yes	Yes	Yes
TYPE	Setpoint Activation Type	No	Yes	No	Yes	Yes	Yes
STBY	Standby Operation	No	Yes	No	Yes	Yes	Yes
HYST	Setpoint Hysteresis	No	No	No	Yes	Yes	No
E-ON	Setpoint On Time Delay	No	No	No	Yes	Yes	Yes
E-OFF	Setpoint Off Time Delay	No	No	No	No	Yes	No
E-OUT	Setpoint Output Time-out Value	Yes	No	No	Yes	No	No
1-SHOT	Rate Timed Output One-shot	No	No	No	Yes	No	No
AUTO	Counter Auto Reset	Yes	No	Yes	No	No	No
RESET	Output Reset with Manual Reset	Yes	No	Yes	No	No	No
RST-Sn	Setpoint Output Reset at Sn+1	Yes	No	Yes	No	No	No

### SETPOINT SELECT



51 52 53 54

Select the Setpoint output to be programmed. The “5n” in the following parameters will reflect the chosen setpoint number. After the chosen setpoint is completely programmed, the display returns to the Setpoint Select menu. Repeat steps for each setpoint to be programmed.

If no output card is installed, programming is still available for all setpoints. This allows the Line 1 color change feature to provide a visual indication when a setpoint value has been reached, even if no setpoint output card is being used.

### SETPOINT ASSIGNMENT



NONE Lnt x RATE x

Select the display to which the setpoint is assigned.

SELECTION	DISPLAY VALUE
NONE	Manual Mode operation (See SERIAL RLC PROTOCOL)
Lnt x	Counter Display Value (x = A, B or C)
RATE x	Rate Display Value (x = A, B or C)

### SETPOINT OUTPUT ACTION



NO LATCH t-OUT BOUND

Select the desired Setpoint Output Action. Choose NO (no action) if a setpoint is unused or for manual mode operation. See “Setpoint (Alarm) Figures for Rate” for a visual detail of Rate Assigned setpoint actions.

#### For Counter Assignments:

LATCH	LATCH Action - The setpoint output activates when the count value equals the setpoint value. The output remains active until reset.
t-OUT	TIMED OUT Action - The setpoint output activates when the count value equals the setpoint value and deactivates after the Time Out value.
BOUND	BOUNDARY Action - The setpoint output activates when the count value is greater than or equal to (for LYPE = HI - RCL) or less than or equal to (for LYPE = LO - RCL) the setpoint value. The setpoint output will deactivate when the count value is less than (for LYPE = HI - RCL) or greater than (for LYPE = LO - RCL) the setpoint value.

#### For Rate Assignments:

LATCH	LATCH Action - The setpoint output activates when the rate value is equal to the setpoint value. The setpoint output remains active until reset. If after reset, the rate value is greater than or equal to (for LYPE = HI - RCL) or less than or equal to (for LYPE = LO - RCL) the setpoint value, the output will reactivate.
t-OUT	TIMED OUT Action - The setpoint output cycles when the rate value is greater than or equal to (for LYPE = HI - RCL) or less than or equal to (for LYPE = LO - RCL) the setpoint value. The Setpoint Time Out (t-OUT) and Setpoint On Delay (t-ON) values determine the cycling times. One-shot mode provides a single output pulse (t-OUT) rather than on/off cycling.
BOUND	BOUNDARY Action - The setpoint output activates when the rate value is greater than or equal to (for LYPE = HI - RCL) or less than or equal to (for LYPE = LO - RCL) the setpoint value. The setpoint output will deactivate (Auto reset) as determined by the Hysteresis value.

### SETPOINT OUTPUT LOGIC



NOr rEU

Normal (NOr) turns the output ON when activated and OFF when deactivated. Reverse (rEU) turns the output OFF when activated and ON when deactivated.

### SETPOINT ANNUNCIATOR



OFF NOr rEU FLASH

OFF disables display setpoint annunciators. Normal (NOr) displays the corresponding setpoint annunciators of ON alarm outputs. Reverse (rEU) displays the corresponding setpoint annunciators of OFF alarm outputs. FLASH flashes the corresponding setpoint annunciators of ON alarm outputs.

### SETPOINT LINE 1 COLOR



NO CHG ORANGE GRNDRB rEdGRN  
GREEN rEd rEdDRB LINE 1

This parameter allows the Line 1 Display to change color, or alternate between two colors, when the alarm is activated. When multiple alarms are programmed to change color, the highest numbered active alarm (S4-S1) determines the display color.

The NO CHG selection will maintain the color displayed prior to the alarm activation. The LINE 1 selection sets the display to the Line 1 Display Color (Color), programmed in the Display menu section.

### SETPOINT VALUE



- 199999 to 999999

Enter the desired Setpoint value. The decimal point position is determined by the Setpoint Assignment display value. Setpoint values can also be entered during Program Lockout, if enabled in the Main or Parameter Display loops. See “Line 2 Display Access” in the Display programming section. A Select Parameter List feature for setpoint values is explained in the User Input (USER) programming section.

### SETPOINT TRACKING



NO 52 54 CLD b  
51 53 CLD A CLD C

If a selection other than NO is chosen, then the value of the setpoint being programmed (“n”) will track the entered selection’s value. Tracking means that when the selection’s value is changed (in the Parameter or Hidden Display loop), the “n” setpoint value will also change (or follow) by the same amount.

### SETPOINT OUTPUT POWER-UP STATE



OFF ON SAVE

OFF will deactivate the output at power up. ON will activate the output at power up. SAVE will restore the output to the same state it was at before the meter was powered down.

### SETPOINT ACTIVATION (BOUNDARY) TYPE



HI - RCL LO - RCL

HI - RCL activates the output when the assigned display value (ASSIGN) equals or exceeds the setpoint value. LO - RCL activates the output when the assigned display value is less than or equal to the setpoint.

### SETPOINT STANDBY OPERATION



NO YES

This parameter only applies to low acting setpoint activation (boundary) type setpoints. Select YES to disable a low acting setpoint at power-up, until the assigned display value crosses into the output “off” area. Once in the output “off” area, the setpoint will function per the description for low acting activation (boundary) type.

### SETPOINT HYSTERESIS

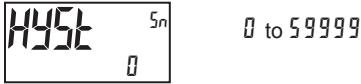

The hysteresis value is added to (for  $TYPE = LO-Act$ ), or subtracted from (for  $TYPE = HI-Act$ ), the setpoint value to determine at what value to deactivate the associated setpoint output. Hysteresis is only available for Rate assigned setpoints.

### SETPOINT ON TIME DELAY



This is the amount of time the assigned Rate display must meet the setpoint activation requirements (below setpoint for Low Acting and above setpoint for High Acting), before the setpoint output activates. If the Rate Setpoint Action is Timed-Out, this is the amount of time the output is OFF during the ON/OFF output cycling. This parameter is only available for Rate assigned setpoints.

### SETPOINT OFF TIME DELAY



This is the amount of time the assigned Rate display must meet the setpoint deactivation requirements (below hysteresis for High Acting and above hysteresis for Low Acting), before the setpoint output deactivates. This parameter is only available for Rate assigned setpoints.

### SETPOINT OUTPUT TIME-OUT



If the setpoint action is Timed Out and the setpoint is assigned to Counter, then this is the amount of time the output will activate once the count value equals the setpoint value. If the setpoint action is Timed Out and the setpoint is assigned to Rate, then this is the amount of time the output is ON during the ON / OFF output cycling. If Rate Timed Output One-Shot mode is enabled, then this is the time duration for the one-shot output pulse.

### RATE TIMED OUTPUT ONE-SHOT



If the setpoint action is Timed Out and the setpoint is assigned to Rate, select YES to have the output activate for a single pulse (one-shot) when the assigned Rate display meets the setpoint activation requirements. Select NO for ON / OFF output cycling per the "Setpoint (Alarm) Figures For Rate" diagram.

### COUNTER AUTO RESET



This automatically resets the display value of the Setpoint Assigned Counter each time the setpoint value is reached. The automatic reset can occur at output start or output end if the setpoint output action is programmed for timed output mode. The counter may be reset to zero or the count load value. This reset may be different from the counter reset action programmed in the Input Parameter ( $INPUT$ ) menu section.

SELECTION	ACTION
NO	No Auto Reset
ZER-5t	Reset to Zero at the Start of output activation
CLD-5t	Reset to Count Load value at the Start of output activation
ZER-En	Reset to Zero at the End of output activation (timed out only)
CLD-En	Reset to Count Load at the End of output activation (timed out only)

### SETPOINT OUTPUT RESET WITH COUNTER RESET



Selecting YES causes the Setpoint output to deactivate (reset) when the Setpoint Assigned Counter is reset. The only exception is when the assigned counter is reset by a setpoint generated counter auto reset.

### SETPOINT OUTPUT RESET AT Sn+1



Selecting Sn-5tr causes the setpoint output to deactivate (reset) when setpoint Sn + 1 activates. (Example: S1 deactivates when S2 activates, and S4 when S1 activates.) The last setpoint will wrap around to the first.

Selecting Sn-End causes the setpoint output to deactivate (reset) when setpoint Sn + 1 activates and then times out (deactivates). This selection only applies if the Sn + 1 setpoint action is Timed Out. (Example: S1 deactivates when S2 is activated and then times out.) The last setpoint will wrap around to the first. This parameter is only available for Counter assigned setpoints.

### Setpoint (Alarm) Figures for Rate

(For Reverse Logic, The Alarm state is opposite.)

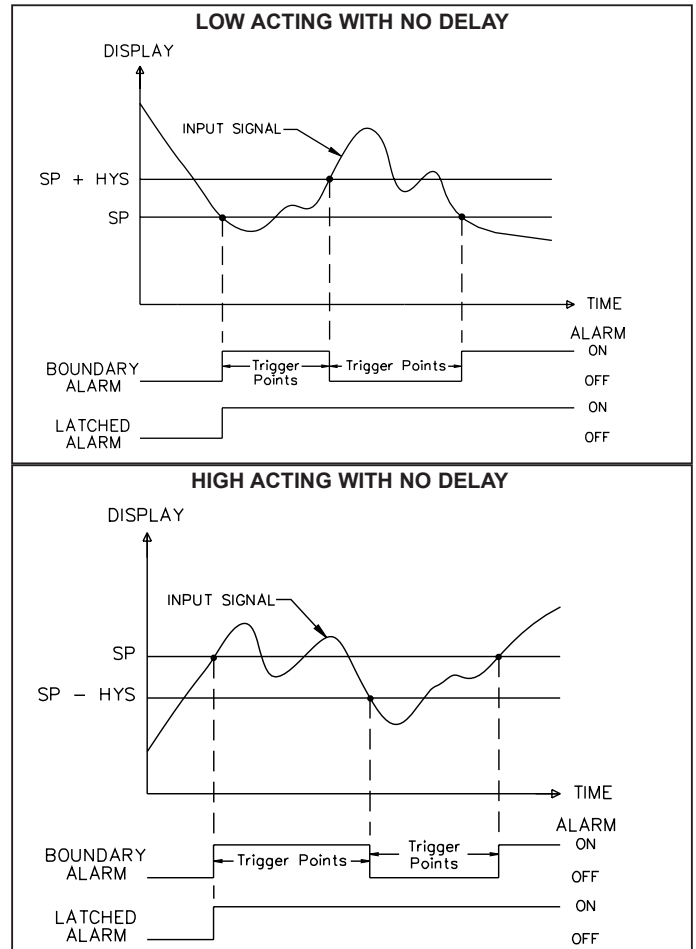

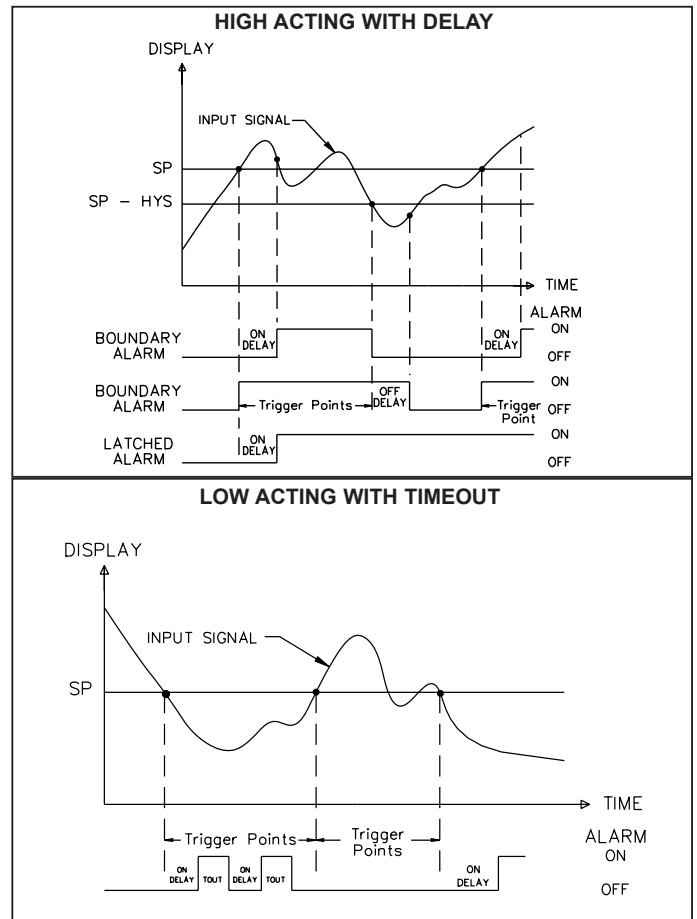
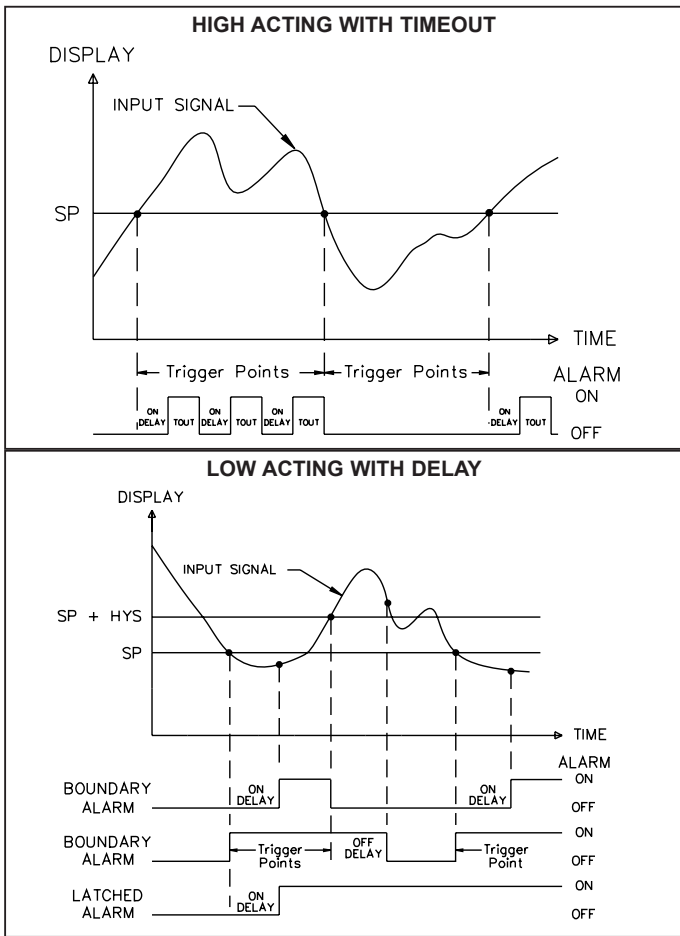

## ANALOG OUTPUT PARAMETERS (ANAL06)

This section is only accessible with the optional PAXCDL Analog card installed (see Ordering Information).

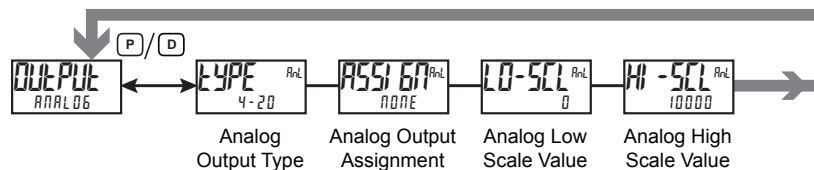

### ANALOG OUTPUT TYPE

TYPE<sup>RnL</sup>  
4-20

0-20 4-20 0-10

Enter the analog output type. For current output (0-20 mA or 4-20 mA) use terminals 18 and 19. For voltage output (0-10 V) use terminals 16 and 17. Only one range can be used at a time.

### ANALOG OUTPUT ASSIGNMENT

ASSIGN<sup>RnL</sup>  
NONE

Select the Display or Setpoint value that the analog output is to follow:

SELECTION	DISPLAY VALUE
NONE	Manual Mode operation (See SERIAL RLC PROTOCOL)
ENT x	Counter Display Value (x = A, B or C)
RATE x	Rate Display Value (x = A, B or C)
H <sub>i</sub>	Maximum Display Value
L <sub>o</sub>	Minimum Display Value
S1 - S4	Setpoint Value (S1-S4)

### ANALOG LOW SCALE VALUE

LO-SCL<sup>RnL</sup>  
0

- 199999 to 999999

Enter the display value within the selected Analog Assignment that corresponds to the low limit of the type selected. The decimal point is determined by the decimal point setting of the assigned counter or rate. The scale value cannot be set to read values with more than 6 digits. Reverse acting output is possible by reversing the scaling values.

### ANALOG HIGH SCALE VALUE

HI-SCL<sup>RnL</sup>  
10000

- 199999 to 999999

Enter the display value within the selected Analog Assignment that corresponds to the high limit of the type selected. The decimal point is determined by the decimal point setting of the assigned counter or rate. The scale value cannot be set to read values with more than 6 digits. Reverse acting output is possible by reversing the scaling values.

# DISPLAY PARAMETERS (dISPLY)

## DISPLAY LINE SELECT



LINE 1      LINE 2

Select the Display Line to be programmed.

## LINE 1 PARAMETERS (LINE 1)

This section details programming for the Line 1 (Top Line) Display. The Counter values, Rate values and the Maximum (Hi) and Minimum (Lo) Rate Capture values can be shown on the Line 1 display. The 3-digit Units mnemonic characters can be used to indicate which Line 1 display value is shown. Standard or custom mnemonics are available for Line 1 values.

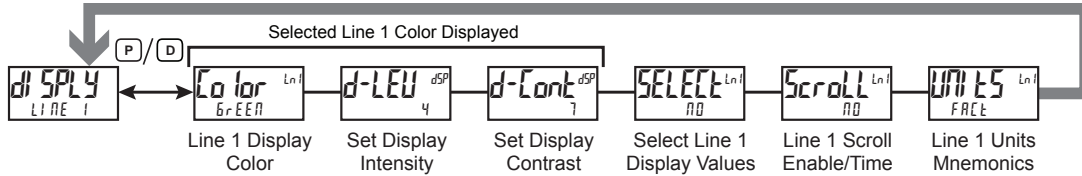

### LINE 1 DISPLAY COLOR



GREEN    red    ORANGE

Select the desired color for the Line 1 Display and Units Mnemonic. The Line 1 display will actively change color as the selection is changed with the arrow keys. This parameter can also be accessed in the Parameter Display Loop when enabled. (see "Line 2 Display Access")

### LINE 1 DISPLAY SCROLL ENABLE/TIME



NO      1 to 15 seconds

If Line 1 Display Scrolling is desired, set the scroll time in seconds.

### DISPLAY INTENSITY LEVEL



1 to 4

Enter the desired Display Intensity Level (1-4) by using the arrow keys. The display will actively dim or brighten as the levels are changed. This parameter can also be accessed in the Parameter Display Loop when enabled.

### LINE 1 UNITS MNEMONIC(S)



OFF    LABEL    CUSTOM    FACT

Select the mode for Line 1 Units Mnemonic(s). See LINE 1 UNITS MNEMONIC DIAGRAM for programming details.

SELECTION	MODE	DESCRIPTION
OFF	OFF	No Line 1 mnemonic shown.
LABEL	LABEL	Single programmable mnemonic shown for all Line 1 values.
CUSTOM	CUSTOM	Custom programmable mnemonics shown for each Line 1 value.
FACT	FACTORY	Factory default mnemonics shown for each Line 1 value.

The characters available for the programmable modes include:

A B C D E F G H I J K L M N O P Q R S T U V W X Y Z  
0 1 2 3 4 5 6 7 8 9 a c e g h i n o q r u - : [ ] ^ \_ . blank

### LINE 1 DISPLAY VALUE SELECT/ENABLE



NO      YES

Enter YES to select which values will be shown on the Line 1 display. A sub-menu provides Yes/No selection for each available Line 1 value. Values set to YES in the sub-menu will be displayed on Line 1.

DISPLAY	DESCRIPTION	FACTORY
Ent A	Counter A	YES
Ent b	Counter B	NO
Ent C	Counter C	NO
Rate A	Rate A	NO
Rate b	Rate B	NO
Rate C	Rate C	NO
Hi	Max Value	NO
Lo	Min Value	NO

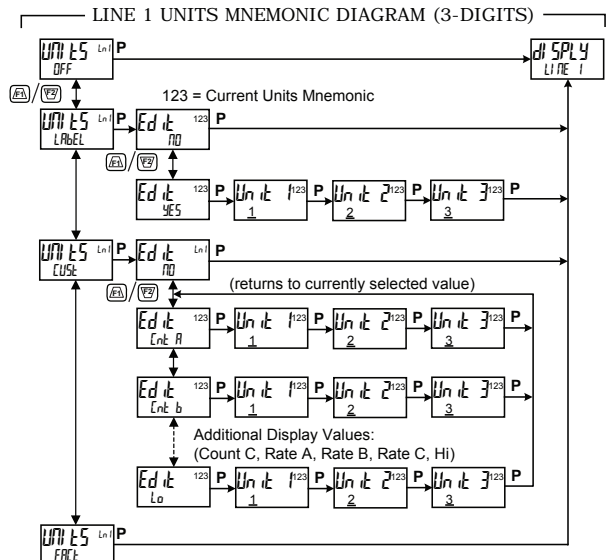

## LINE 2 PARAMETERS (LINE 2)

This section details programming for the Line 2 (Bottom Line) Display. The Counter values, Rate values, Rate Capture values, Setpoint values and Parameter List A/B status can all be shown on the Line 2 display. The Display Loops described below are used to view, reset and modify the selected display values, based on the Line 2 Value Access setting programmed for each available value.

### Main Display Loop

In the Main Display Loop, the selected values can be consecutively read on Line 2 by pressing the **D** key. A left justified 2 or 3-character mnemonic indicates which Line 2 value is currently shown. When in the Main Display Loop, the Function keys **F1** and **F2** perform the User functions programmed in the User Input program section.

### Parameter Display Loop and Hidden Parameter Loop

These display loops provide quick access to selected parameters that can be viewed and modified on Line 2 without having to enter Full Programming Mode. These values include Parameter List A/B selection, Setpoints, Scale Factors, Counter Load values and Display Settings (color, intensity and contrast). To utilize the Parameter Display or Hidden Parameter Loops, a security code (1-250) must be programmed. (See Programming Security Code at the end of this section.)

The Parameter Display Loop is accessed by pressing the **P** key. The selected Parameter Display Loop values can be viewed and/or changed per the Line 2 Value Access setting programmed for each available value. The Hidden Parameter Loop follows the Parameter Display Loop, and can only be accessed when the correct security code is entered at the Code prompt.

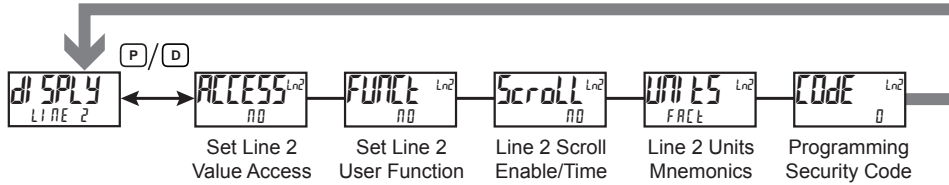

### LINE 2 VALUE ACCESS



Select **4E5** to program the Value Access setting for each available Line 2 parameter. Line 2 values can be made accessible in either the Main (**D** key), Parameter (**P** key) or Hidden (**H** idE key following code entry) Display Loops.

Each parameter must be configured for one of the following settings. Not all settings are available for each parameter, as shown in the Parameter Value Access table.

SELECTION	DESCRIPTION
<b>L0E</b>	Not viewed on Line 2 Display (Factory Default Setting)
<b>d-rERd</b>	View in Main Display Loop. Cannot change or reset.
<b>d-r5t</b>	View and reset in Main Display Loop.
<b>d-EntEr</b>	View and change in Main Display Loop
<b>P-rERd</b>	View in Parameter Display Loop. Cannot change or reset.
<b>P-EntEr</b>	View and change in Parameter Display Loop
<b>H idE</b>	View and change in Hidden Parameter Display Loop

### LINE 2 FUNCTIONS ACCESS



Select **4E5** to display the following list of functions that can be made available at the end of the Parameter (**P-EntEr**) or Hidden (**H idE**) display loops. Most of these functions provide direct value resets, which are not available as User Input or Function Key functions.

SELECTION	DESCRIPTION
<b>r-L1</b>	Reset Line 1 Display Value
<b>r-ctA</b>	Reset Counter A
<b>r-ctB</b>	Reset Counter B
<b>r-ctC</b>	Reset Counter C
<b>r-AbC</b>	Reset Counters A, B and C
<b>r-H1</b>	Reset Maximum Rate Capture Value
<b>r-L0</b>	Reset Minimum Rate Capture Value
<b>r-HL</b>	Reset Max and Min Rate Capture Values
<b>Pr int</b>	Print Request (Block Print)

### LINE 2 PARAMETER VALUE ACCESS

DISPLAY	DESCRIPTION	NOT VIEWED	MAIN DISPLAY LOOP (D KEY)			PARAMETER DISPLAY LOOP (P KEY)		HIDDEN LOOP
			L0E	d-rERd	d-r5t	d-EntEr	P-rERd	
<b>Ent A</b>	Counter A	X	X	X				
<b>Ent b</b>	Counter B	X	X	X				
<b>Ent C</b>	Counter C	X	X	X				
<b>RAte A</b>	Rate A	X	X					
<b>RAte b</b>	Rate B	X	X					
<b>RAte C</b>	Rate C	X	X					
<b>H1</b>	Max Value	X	X	X				
<b>L0</b>	Min Value	X	X	X				
<b>L15t</b>	Parameter List A/B	X	X		X	X	X	X
<b>5n</b>	Setpoint Value (S1-S4) *	X	X		X	X	X	X
<b>5E FAc</b>	Scale Factor A, B, C *	X				X	X	X
<b>Ent Ld</b>	Counter Load A, B, C *	X				X	X	X
<b>Co lor</b>	Line 1 Display Color	X				X	X	X
<b>d-LEU</b>	Display Intensity Level	X				X	X	X
<b>d-Cont</b>	Display Contrast Level	X				X	X	X

\* Indicates multiple value entries.

## LINE 2 DISPLAY SCROLL ENABLE/TIME



n0 1 to 15 seconds

If Line 2 Display Scrolling is desired, set the scroll time in seconds.

## LINE 2 UNITS MNEMONIC(S)



OFF [USE] Lb-EST Lb Ln1  
LABEL FACT Lb-FAC L1-FAC

Select the mode for Line 2 Units Mnemonic(s). See LINE 2 UNITS MNEMONIC DIAGRAM for programming details.

SELECTION	MODE	DESCRIPTION
OFF	OFF	No Line 2 mnemonics shown.
LABEL	LABEL	Single programmable mnemonic shown as a separate item in the Line 2 Display loop. No individual mnemonics are shown with the other Line 2 Display values.
[USE]	CUSTOM	Individual Custom programmable mnemonics shown with each value in the Line 2 Display loop.
FACT	FACTORY	Individual Factory default mnemonics shown with each value in the Line 2 Display loop.
Lb-EST	LABEL & CUSTOM	A programmable mnemonic shown as a separate item in the Line 2 Display loop. Also, individual Custom programmable mnemonics shown with each value in the Line 2 Display loop.
Lb-FAC	LABEL & FACTORY	A programmable mnemonic shown as a separate item in the Line 2 Display loop. Also, individual Factory default mnemonics shown with each value in the Line 2 Display loop.
Lb Ln1	LINE 1 INDEXED LABELS	Individual programmable mnemonics, indexed to the Line 1 Display value, are shown as a separate item in the Line 2 Display loop. These same mnemonics are also shown with each value in the Line 2 Display loop.
L1-FAC	LINE 1 INDEXED LABELS & FACTORY	Individual programmable mnemonics, indexed to the Line 1 Display value, are shown as a separate item in the Line 2 Display loop. Also, individual Factory default mnemonics are shown with each value in the Line 2 Display loop.

The characters available for the programmable modes include:

A b c d e f g h i j k l m n o p q r s t u v w x y z 0 1  
2 3 4 5 6 7 8 9 a c e g h i n o u - : [ ] ^ \_ blank

## LINE 2 UNITS MNEMONIC DIAGRAM (9-DIGITS)

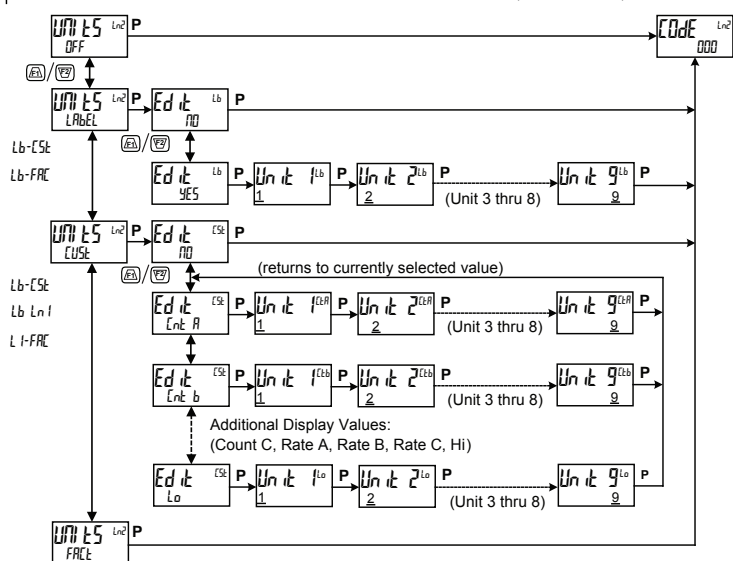

## PROGRAMMING SECURITY CODE



0 to 250

To activate either the Parameter or Hidden Parameter Display Loops, a security code (1-250) must be entered. If a "0" security code is programmed, pressing the **P** key takes you directly to the Full Programming Mode.

The Security Code determines the programming mode and the accessibility of programming parameters. This code can be used along with the Program Mode Lock-out (PLDL) function, programmed in the User Input parameter section (USER).

Two programming modes are available. Full Programming Mode allows all parameters to be viewed and modified. Parameter Display Loop mode provides access to those selected parameters, that can be viewed and/or modified without entering the Full programming mode.

The following chart indicates the levels of access based on various CODE and User Input PLDL settings.

SECURITY CODE	USER INPUT CONFIGURED	USER INPUT STATE	WHEN P KEY IS PRESSED	FULL PROGRAMMING MODE ACCESS
0	not PLDL	_____	Full Programming	Immediate Access
>0	not PLDL	_____	Enter Parameter Display Loop	After Parameter Display Loop with correct code # at CODE prompt.
>0	PLDL	Active	Enter Parameter Display Loop	After Parameter Display Loop with correct code # at CODE prompt.
>0	PLDL	Not Active	Full Programming	Immediate Access
0	PLDL	Active	Enter Parameter Display Loop	No Access
0	PLDL	Not Active	Full Programming	Immediate Access

# COMMUNICATIONS PORT PARAMETERS (Port)

## PORT SELECT



USB SERIAL

Select the Communications Port to be programmed.

## USB PORT PARAMETERS (USB)

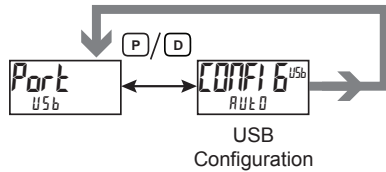

## USB CONFIGURATION



AUTO SERIAL

**AUTO** Meter automatically configures USB port settings to operate with Crimson configuration software. When a USB cable is attached to PAX2D and PC, the port is internally set to Modbus RTU protocol, 38400 baud, 8 bits, and Unit Address 247. The Serial Port settings programmed below will not change, or show this.

**SERIAL** Configures USB port to utilize the Serial Port settings and protocol programmed below.

## SERIAL PORT PARAMETERS (SERIAL)

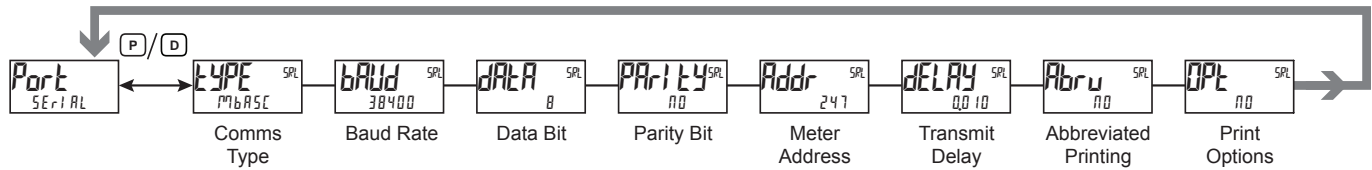

### COMMUNICATIONS TYPE



MODBUS - Modbus RTU  
 MODASCII - Modbus ASCII  
 RLC - RLC Protocol (ASCII)

Select the desired communications protocol. Modbus is preferred as it provides access to all meter values and parameters. Since the Modbus protocol is included within the PAX2D, the PAX Modbus option card, PAXCDC4, should not be used. The PAXCDC1 (RS485), or PAXCDC2 (RS232) card should be used instead.

### PARITY BIT



NO EVEN ODD

Set the parity bit to match that of the other serial communications equipment on the serial link. The meter ignores the parity when receiving data and sets the parity bit for outgoing data. If no parity is selected with 7 bit word length, an additional stop bit is used to force the frame size to 10 bits.

### BAUD RATE



1200    4800    19200  
 2400    9600    38400

Set the baud rate to match the other serial communications equipment on the serial link. Normally, the baud rate is set to the highest value that all the serial equipment are capable of transmitting and receiving.

### METER UNIT ADDRESS



1 to 247 - Modbus  
 0 to 99 - RLC Protocol

Select a Unit Address that does not match an address number of any other equipment on the serial link.

### DATA BIT

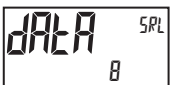

7    8

Select either 7 or 8 bit data word lengths. Set the word length to match the other serial communications equipment on the serial link.

### TRANSMIT DELAY



0.000 to 0.250 seconds

Following a Modbus command or RLC Transmit Value command, the PAX2D will wait this minimum amount of time in seconds before issuing a serial response



The following programming steps are only available when Communications Type (TYPE) is programmed for RLC Protocol (RLC).

### ABBREVIATED PRINTING



NO YES

Select NO for full print or Command T transmissions (meter address, mnemonics and parameter data) or YES for abbreviated print transmissions (parameter data only). This will affect all the parameters selected in the print options. If the meter address is 00, it will not be sent during a full transmission.

### PRINT OPTIONS



NO YES

YES - Enters the sub-menu to select the meter parameters to appear during a print request. For each parameter in the sub-menu, select YES for that parameter

information to be sent during a print request or NO for that parameter information not to be sent. A print request is sometimes referred to as a block print because more than one parameter information (meter address, mnemonics and parameter data) can be sent to a printer or computer as a block.

DISPLAY	DESCRIPTION	FACTORY SETTING	MNEMONIC
Cnt A	Counter A	YES	CTA
Cnt B	Counter B	NO	CTB
Cnt C	Counter C	NO	CTC
Rate A	Rate A	NO	RTA
Rate B	Rate B	NO	RTB
Rate C	Rate C	NO	RTC
Hi	Max Value	NO	MAX
Lo	Min Value	NO	MIN
SC FAC	Scale Factor A & B	NO	SFA, SFB
Cnt Ld	Counter Load A & B	NO	CLA, CLB
SETPnt	Setpoint Values	NO	SP1 - SP4

## SERIAL COMMUNICATIONS

The PAX2D supports serial communications using the optional serial communication cards or via the USB programming port located on the side of the unit. When USB is being used (connected), the serial communication card is disabled. When using the standard RS232 and RS485 Pax option cards, the PAX2D supports both the RLC protocol and also supports Modbus communications. The Pax Modbus option card should not be used with the PAX2D, as the PAX2D internal Modbus protocol supports complete unit configuration, and is much more responsive.

### USB

The USB programming port is primarily intended to be used to configure the PAX2D with the Crimson programming software. It can also be used as a virtual serial communications port following installation of the PAX2D USB drivers that are supplied with the Crimson software. When the USB port is being used, i.e. the USB cable is connected between PAX2D and PC, all serial communications with the serial option card (if used) is disabled.

USB Cable type required: USB A to Mini-B (not supplied)

#### PAX2D CONFIGURATION USING CRIMSON AND USB

1. Install Crimson software.
2. Supply power to PAX2D.
3. Insure USB Configuration (CONF B) in USB Port Parameters is set to AUTO (factory default setting).
4. Attach USB cable (USB A to Mini-B) between PC and PAX2D.
5. Create a new file (File, New) or open an existing PAX2D database within Crimson.
6. Configure Crimson Link options (Link, Options) to the serial port which the USB cable is attached (in Step 4).

### SERIAL MODBUS COMMUNICATIONS

Modbus Communications requires that the Serial Communications Type Parameter (TYPE) be set to Modbus RTU (RTU) or Modbus ASCII (ASCII).

#### PAX2D CONFIGURATION USING CRIMSON AND SERIAL COMMUNICATIONS CARD

1. Install Crimson software.
2. Install RS232 or RS485 card and connect communications cable from PAX2D to PC.
3. Supply power to PAX2D.
4. Configure serial parameters (SERIAL) to Modbus RTU (RTU), 38,400 baud, address 247.
5. Create a new file (File, New) or open an existing PAX2D database within Crimson.
6. Configure Crimson Link options (Link, Options) to the serial port which the communication cable is attached (in step 2).

### SUPPORTED FUNCTION CODES

#### FC03: Read Holding Registers

1. Up to 64 registers can be requested at one time.
2. HEX <8000> is returned for non-used registers.

#### FC04: Read Input Registers

1. Up to 64 registers can be requested at one time.
2. Block starting point can not exceed register boundaries.
3. HEX <8000> is returned in registers beyond the boundaries.
4. Input registers are a mirror of Holding registers.

#### FC06: Preset Single Register

1. HEX <8001> is echoed back when attempting to write to a read only register.
2. If the write value exceeds the register limit (see Register Table), then that register value changes to its high or low limit. It is also returned in the response.

#### FC16: Preset Multiple Registers

1. No response is given with an attempt to write to more than 64 registers at a time.
2. Block starting point cannot exceed the read and write boundaries (40001-41280).
3. If a multiple write includes read only registers, then only the write registers will change.
4. If the write value exceeds the register limit (see Register Table), then that register value changes to its high or low limit.

#### FC08: Diagnostics

The following is sent upon FC08 request:

Module Address, 08 (FC code), 04 (byte count), "Total Comms" 2 byte count, "Total Good Comms" 2 byte count, checksum of the string  
 "Total Comms" is the total number of messages received that were addressed to the PAX2. "Total Good Comms" is the total messages received by the PAX2D with good address, parity and checksum. Both counters are reset to 0 upon response to FC08 and at power-up.

#### FC17: Report Slave ID

The following is sent upon FC17 request:

RLC-PAX2D ab<0100h><40h><40h><10h>  
 a = SP Card, "0"-No SP, "2" or "4" SP  
 b = Linear Card "0" = None, "1" = Yes  
 <0100> Software Version Number (1.00)  
 <40h>Max Register Reads (64)  
 <40h>Max Register Writes (64)  
 <10h> Number Guid/Scratch Pad Regs (16)

### SUPPORTED EXCEPTION CODES

#### 01: Illegal Function

Issued whenever the requested function is not implemented in the meter.

#### 02: Illegal Data Address

Issued whenever an attempt is made to access a single register that does not exist (outside the implemented space) or to access a block of registers that falls completely outside the implemented space.

#### 03: Illegal Data Value

Issued when an attempt is made to read or write more registers than the meter can handle in one request.

#### 07: Negative Acknowledge

Issued when a write to a register is attempted with an invalid string length.

## PAX2D MODBUS REGISTER TABLE

Values less than 65,535 will be in (Lo word). Values greater than 65,535 will continue into (Hi word). Negative values are represented by two's complement of the combined (Hi word) and (Lo word).

Note 1: The PAX2D should not be powered down while parameters are being changed. Doing so may corrupt the non-volatile memory resulting in checksum errors.

REGISTER ADDRESS	REGISTER NAME	LOW LIMIT	HIGH LIMIT	FACTORY SETTING	ACCESS	COMMENTS
<b>FREQUENTLY USED REGISTERS</b>						
40001	Counter A Value (Hi word)	-199999999	999999999	0	Read/Write	
40002	Counter A Value (Lo word)					
40003	Counter B Value (Hi word)	-199999999	999999999	0	Read/Write	
40004	Counter B Value (Lo word)					
40005	Counter C Value (Hi word)	-199999999	999999999	0	Read/Write	
40006	Counter C Value (Lo word)					
40007	Rate A Value (Hi word)	N/A	N/A	N/A	Read Only	
40008	Rate A Value (Lo word)					
40009	Rate B Value (Hi word)	N/A	N/A	N/A	Read Only	
40010	Rate B Value (Lo word)					
40011	Rate C Value (Hi word)	N/A	N/A	N/A	Read Only	
40012	Rate C Value (Lo word)					
40013	Max (Hi) Value (Hi word)	-199999	999999	0	Read/Write	
40014	Max (Hi) Value (Lo word)					
40015	Min (Lo) Value (Hi word)	-199999	999999	0	Read/Write	
40016	Min (Lo) Value (Lo word)					
40017	Setpoint 1 Value (Hi word)	-199999	999999	100	Read/Write	Active List (A or B)
40018	Setpoint 1 Value (Lo word)					
40019	Setpoint 2 Value (Hi word)	-199999	999999	200	Read/Write	Active List (A or B)
40020	Setpoint 2 Value (Lo word)					
40021	Setpoint 3 Value (Hi word)	-199999	999999	300	Read/Write	Active List (A or B)
40022	Setpoint 3 Value (Lo word)					
40023	Setpoint 4 Value (Hi word)	-199999	999999	400	Read/Write	Active List (A or B)
40024	Setpoint 4 Value (Lo word)					
40025	Counter A Scale Factor (Hi word)	1	999999	100000	Read/Write	Active List (A or B)
40026	Counter A Scale Factor (Lo word)					
40027	Counter B Scale Factor (Hi word)	1	999999	100000	Read/Write	Active List (A or B)
40028	Counter B Scale Factor (Lo word)					
40029	Counter C Scale Factor (Hi word)	1	999999	100000	Read/Write	Active List (A or B)
40030	Counter C Scale Factor (Lo word)					
40031	Counter A Count Load (Hi word)	-199999	999999	500	Read/Write	Active List (A or B)
40032	Counter A Count Load (Lo word)					
40033	Counter B Count Load (Hi word)	-199999	999999	500	Read/Write	Active List (A or B)
40034	Counter B Count Load (Lo word)					
40035	Counter C Count Load (Hi word)	-199999	999999	500	Read/Write	Active List (A or B)
40036	Counter C Count Load (Lo word)					
40037	Setpoint Output Register (SOR)	0	15	N/A	Read/Write	Status of Setpoint Outputs. Bit State: 0=Off, 1=On. Bit 3 = S1, Bit 2 = S2, Bit 1 = S3, Bit 0 = S4. Outputs can only be activated/reset with this register when the respective bits in the Manual Mode Register (MMR) are set.
40038	Manual Mode Register (MMR)	0	31	0	Read/Write	Bit State: 0 = Auto Mode, 1 = Manual Mode Bit 4 = S1, Bit 3 = S2, Bit 2 = S3, Bit 1 = S4, Bit 0 = Linear Output
40039	Reset Output Register	0	15	0	Read/Write	Bit State: 1= Reset Output, bit is returned to zero following reset processing; Bit 3 = S1, Bit 2 = S2, Bit 1 = S3, Bit 0 = S4
40040	Analog Output Register (AOR)	0	4095	0	Read/Write	Linear Output Card written to only if Linear Output is in Manual Mode (MMR bit 0 = 1).
<b>A/B SELECTION LIST PARAMETERS</b>						
<b>SEE USER LIST FUNCTION IN INPUT MODULE FOR DETAILS</b>						
<b>List A</b>	<b>List B</b>	<b>Setpoint Values</b>				
40041	40081	Setpoint 1 Value (Hi word)	-199999	999999	100	Read/Write
40042	40082	Setpoint 1 Value (Lo word)				
40043	40083	Setpoint 2 Value (Hi word)	-199999	999999	200	Read/Write
40044	40084	Setpoint 2 Value (Lo word)				
40045	40085	Setpoint 3 Value (Hi word)	-199999	999999	300	Read/Write
40046	40086	Setpoint 3 Value (Lo word)				
40047	40087	Setpoint 4 Value (Hi word)	-199999	999999	400	Read/Write
40048	40088	Setpoint 4 Value (Lo word)				
<b>Counter Scale Factor Values</b>						
40049	40089	Counter A Scale Factor (Hi word)	1	999999	100000	Read/Write
40050	40090	Counter A Scale Factor (Lo word)				

REGISTER ADDRESS	REGISTER NAME	LOW LIMIT	HIGH LIMIT	FACTORY SETTING	ACCESS	COMMENTS	
40051	40091	Counter B Scale Factor (Hi word)	1	999999	100000	Read/Write	1 = 0.00001 (decimal point fixed)
40052	40092	Counter B Scale Factor (Lo word)					
40053	40093	Counter C Scale Factor (Hi word)	1	999999	100000	Read/Write	1 = 0.00001 (decimal point fixed)
40054	40094	Counter C Scale Factor (Lo word)					
<b>Counter Count Load Values</b>							
40055	40095	Counter A Count Load (Hi word)	-199999	999999	500	Read/Write	1 = 1 in least significant digit (disregard decimal point)
40056	40096	Counter A Count Load (Lo word)					
40057	40097	Counter B Count Load (Hi word)	-199999	999999	500	Read/Write	1 = 1 in least significant digit (disregard decimal point)
40058	40098	Counter B Count Load (Lo word)					
40059	40099	Counter C Count Load (Hi word)	-199999	999999	500	Read/Write	1 = 1 in least significant digit (disregard decimal point)
40060	40100	Counter C Count Load (Lo word)					
<b>INPUT PARAMETERS</b>		<b>SEE INPUT MODULE FOR PARAMETER DESCRIPTIONS</b>					
<b>Counter A</b>							
40121	Counter A Operating Mode	0	13	0	Read/Write	0 = None 1 = Count 2 = Count U/D 3 = Dual Count U/D 4 = Add/Add 5 = Add/Sub 6 = Quad x1 7 = Quad x2 8 = Quad x4 9 = Dual Quad x1 10 = Dual Quad x2 11 = Count x2 12 = Count U/D x2 13 = Dual Count U/D x2	
40122	Counter A Decimal Point	0	5	0	Read/Write	0 = 0, 1 = 0.0, 2 = 0.00, 3 = 0.000, 4 = 0.0000, 5 = 0.00000	
40123	Counter A Scale Multiplier	0	3	0	Read/Write	0 = 1, 1 = 0.1, 2 = 0.01, 3 = 10	
40124	Counter A Reset Action	0	1	0	Read/Write	0 = Reset to Zero, 1 = Reset to Counter A Count Load Value	
40125	Counter A Reset at Power-up	0	1	0	Read/Write	0 = No, 1 = Yes	
40126	Input A Active Count Edge (Logic)	0	1	0	Read/Write	0 = Falling Edge, 1 = Rising Edge	
40127	Prescaler Output Enable	0	1	0	Read/Write	0 = No, 1 = Yes	
40128	Prescaler Output Scale Value	1	10000	10000	Read/Write	1 = 0.0001	
<b>Counter B</b>							
40131	Counter B Operating Mode	0	7	0	Read/Write	0 = None 1 = Batch 2 = Count 3 = Dual Count U/D 4 = Dual Quad x1 5 = Dual Quad x2 6 = Count x2 7 = Dual Count U/D x2	
40132	Counter B Decimal Point	0	5	0	Read/Write	0 = 0, 1 = 0.0, 2 = 0.00, 3 = 0.000, 4 = 0.0000, 5 = 0.00000	
40133	Counter B Scale Multiplier	0	3	0	Read/Write	0 = 1, 1 = 0.1, 2 = 0.01, 3 = 10	
40134	Counter B Reset Action	0	1	0	Read/Write	0 = Reset to Zero, 1 = Reset to Counter B Count Load Value	
40135	Counter B Reset at Power-up	0	1	0	Read/Write	0 = No, 1 = Yes	
40136	Input B Active Count Edge (Logic)	0	1	0	Read/Write	0 = Falling Edge, 1 = Rising Edge	
40137	Counter B Batch Count Source	0	15	0	Read/Write	Bit State: 0 = No, 1 = Yes Bit 3 = S4, Bit 2 = S3, Bit 1 = S2, Bit 0 = S1	
<b>Counter C</b>							
40141	Counter C Operating Mode	0	6	0	Read/Write	0 = None 1 = Counter A 2 = Counter B 3 = Add (A+B) 4 = Subtract (A-B) 5 = Batch 6 = Slave	
40142	Counter C Decimal Point	0	5	0	Read/Write	0 = 0, 1 = 0.0, 2 = 0.00, 3 = 0.000, 4 = 0.0000, 5 = 0.00000	
40143	Counter C Scale Multiplier	0	3	0	Read/Write	0 = 1, 1 = 0.1, 2 = 0.01, 3 = 10	
40144	Counter C Reset Action	0	1	0	Read/Write	0 = Reset to Zero, 1 = Reset to Counter C Count Load Value	
40145	Counter C Reset at Power-up	0	1	0	Read/Write	0 = No, 1 = Yes	
40146	Counter C Batch Count Source	0	15	0	Read/Write	Bit State: 0 = No, 1 = Yes Bit 3 = S4, Bit 2 = S3, Bit 1 = S2, Bit 0 = S1	
<b>Rate A</b>							
40151	Rate A Enable	0	1	0	Read/Write	0 = No, 1 = Yes	
40152	Rate A Decimal Point	0	4	0	Read/Write	0 = 0, 1 = 0.0, 2 = 0.00, 3 = 0.000, 4 = 0.0000	
40153	Rate A Low Cut-Out Value (Hi word)	0	999999	0	Read/Write	1 = 1 in least significant digit (disregard decimal point)	
40154	Rate A Low Cut-Out Value (Lo word)						
40155	Rate A Display Rounding	0	6	0	Read/Write	0 = 1, 1 = 2, 2 = 5, 3 = 10, 4 = 20, 5 = 50, 6 = 100	
40156	Rate A Scaling Points	2	10	2	Read/Write	Number of Rate A Linearizer Scaling Points	
40157	Scaling Pt.1 Display Value (Hi word)	0	999999	0	Read/Write	1 = 1 in least significant digit (disregard decimal point)	
40158	Scaling Pt.1 Display Value (Lo word)						
40159	Scaling Pt.1 Input Value (Hi word)	0	999999	0	Read/Write	1 = 0.1Hz	
40160	Scaling Pt.1 Input Value (Lo word)						
40161	Scaling Pt.2 Display Value (Hi word)	0	999999	1000	Read/Write	1 = 1 in least significant digit (disregard decimal point)	
40162	Scaling Pt.2 Display Value (Lo word)						
40163	Scaling Pt.2 Input Value (Hi word)	0	999999	10000	Read/Write	1 = 0.1Hz	
40164	Scaling Pt.2 Input Value (Lo word)						
thru	Scaling Pts. 3 thru 9 Values	...	...	...	Read/Write	Registers 40165-40192 hold values for Scaling Points 3 thru 9.	
40193	Scaling Pt.10 Display Value (Hi word)	0	999999	0	Read/Write	1 = 1 in least significant digit (disregard decimal point)	
40194	Scaling Pt.10 Display Value (Lo word)						
40195	Scaling Pt.10 Input Value (Hi word)	0	999999	0	Read/Write	1 = 0.1Hz	
40196	Scaling Pt.10 Input Value (Lo word)						

REGISTER ADDRESS	REGISTER NAME	LOW LIMIT	HIGH LIMIT	FACTORY SETTING	ACCESS	COMMENTS
	<b>Rate B</b>					
40201	Rate B Enable	0	1	0	Read/Write	0 = No, 1 = Yes
40202	Rate B Decimal Point	0	4	0	Read/Write	0 = 0, 1 = 0.0, 2 = 0.00, 3 = 0.000, 4 = 0.0000
40203	Rate B Low Cut-Out Value (Hi word)	0	999999	0	Read/Write	1 = 1 in least significant digit (disregard decimal point)
40204	Rate B Low Cut-Out Value (Lo word)					
40205	Rate B Display Rounding	0	6	0	Read/Write	0 = 1, 1 = 2, 2 = 5, 3 = 10, 4 = 20, 5 = 50, 6 = 100
40206	Rate B Scaling Points	2	10	2	Read/Write	Number of Rate B Linearizer Scaling Points
40207	Scaling Pt.1 Display Value (Hi word)	0	999999	0	Read/Write	1 = 1 in least significant digit (disregard decimal point)
40208	Scaling Pt.1 Display Value (Lo word)					
40209	Scaling Pt.1 Input Value (Hi word)	0	999999	0	Read/Write	1 = 0.1Hz
40210	Scaling Pt.1 Input Value (Lo word)					
40211	Scaling Pt.2 Display Value (Hi word)	0	999999	1000	Read/Write	1 = 1 in least significant digit (disregard decimal point)
40212	Scaling Pt.2 Display Value (Lo word)					
40213	Scaling Pt.2 Input Value (Hi word)	0	999999	10000	Read/Write	1 = 0.1Hz
40214	Scaling Pt.2 Input Value (Lo word)					
thru	Scaling Pts. 3 thru 9 Values	...	...	...	Read/Write	Registers 40215-40242 hold values for Scaling Points 3 thru 9.
40243	Scaling Pt.10 Display Value (Hi word)	0	999999	0	Read/Write	1 = 1 in least significant digit (disregard decimal point)
40244	Scaling Pt.10 Display Value (Lo word)					
40245	Scaling Pt.10 Input Value (Hi word)	0	999999	0	Read/Write	1 = 0.1Hz
40246	Scaling Pt.10 Input Value (Lo word)					
	<b>Rate C</b>					
40251	Rate C Calculation	0	1	0	Read/Write	0 = None 2 = Difference (A-B) 4 = Pct.of Total (A/A+B) 1 = Sum (A+B) 3 = Ratio (A/B) 5 = Pct.Draw (A-B/B)
40252	Rate C Display Multiplier	0	3	0	Read/Write	0 = 1, 1 = 10, 2 = 100, 3 = 1000
40253	Rate C Decimal Point	0	4	0	Read/Write	0 = 0, 1 = 0.0, 2 = 0.00, 3 = 0.000, 4 = 0.0000
	<b>Rate Update</b>					
40254	Rate Low Update Time	1	9999	10	Read/Write	1 = 0.1 Sec (decimal point fixed)
40255	Rate High Update Time	2	9999	20	Read/Write	2 = 0.2 Sec (decimal point fixed)
	<b>Rate Hi/Lo Capture</b>					
40256	Max (Hi) Capture Value Assignment	0	2	0	Read/Write	0 = Rate A, 1 = Rate B, 2 = Rate C
40257	Max (Hi) Capture Delay Time	0	9999	10	Read/Write	1 = 0.1 Sec (decimal point fixed)
40258	Min (Lo) Capture Value Assignment	0	2	0	Read/Write	0 = Rate A, 1 = Rate B, 2 = Rate C
40259	Min (Lo) Capture Delay Time	0	9999	10	Read/Write	1 = 0.1 Sec (decimal point fixed)
	<b>User Input / Function Keys</b>					
40271	User Input Active State	0	1	0	Read/Write	0 = Active Low, 1 = Active High
40272	User Input 1 Action	0	23	0	Read/Write	0 = NO 7 = Color 14 = RSt-L 21 = SPS-L 1 = PLOC 8 = d-LEV 15 = RSt-E 22 = SPS-E 2 = SEL L1 9 = d-Cont 16 = Inhibit 23 = SPHOLD 3 = SEL L2 10 = d-OFF 17 = StorE 4 = RSt L1 11 = LISt 18 = St-rSt 5 = RSt L2 12 = Print 19 = SPPr-L 6 = RStL12 13 = Pr-rSt 20 = SPPr-E
40273	User Input 1 Assignment	0	31	0	Read/Write	Counter/Hi/Lo Asn (Bit State: 0 = No, 1 = Yes): Bit 0 = CTA, Bit 1 = CTB, Bit 2 = CTC, Bit 3 = Hi, Bit 4 = Lo Setpoint Asn: Bit 0 = S1, Bit 1 = S2, Bit 2 = S3, Bit 3 = S4 List Asn: Bit 3 = Units Mnemonics
40274	User Input 2 Action	0	23	0	Read/Write	Same as User Input 1 Action
40275	User Input 2 Assignment	0	31	0	Read/Write	Same as User Input 1 Assignment
40276	User Input 3 Action	0	23	0	Read/Write	Same as User Input 1 Action
40277	User Input 3 Assignment	0	31	0	Read/Write	Same as User Input 1 Assignment
40278	User F1 Key Action	0	22	1	Read/Write	0 = NO 6 = Color 12 = Pr-rSt 18 = SPPr-L 1 = SEL L1 7 = d-LEV 13 = RSt-L 19 = SPPr-E 2 = SEL L2 8 = d-Cont 14 = RSt-E 20 = SPS-L 3 = RSt L1 9 = d-OFF 15 = Inhibit 21 = SPS-E 4 = RSt L2 10 = LISt 16 = StorE 22 = SPHOLD 5 = RSt L12 11 = Print 17 = St-rSt
40279	User F1 Key Assignment	0	31	0	Read/Write	Same as User Input 1 Assignment
40280	User F2 Key Action	0	22	0	Read/Write	Same as User F1 Key Action
40281	User F2 Key Assignment	0	31	0	Read/Write	Same as User Input 1 Assignment
40282	User F1 Second Action	0	22	0	Read/Write	Same as User F1 Key Action
40283	User F1 Second Action Assignment	0	31	0	Read/Write	Same as User Input 1 Assignment
40284	User F2 Second Action	0	22	0	Read/Write	Same as User F1 Key Action
40285	User F2 Second Action Assignment	0	31	0	Read/Write	Same as User Input 1 Assignment

REGISTER ADDRESS	REGISTER NAME	LOW LIMIT	HIGH LIMIT	FACTORY SETTING	ACCESS	COMMENTS
	<b>OUTPUT PARAMETERS</b>					<b>SEE OUTPUT MODULE FOR PARAMETER DESCRIPTIONS</b>
	<b>Setpoint 1</b>					
40291	Assignment	0	6	0	Read/Write	0 = None, 1 = Counter A, 2 = Counter B, 3 = Counter C, 4 = Rate A, 5 = Rate B, 6 = Rate C
40292	Action	0	3	0	Read/Write	0 = No, 1 = Latch, 2 = Timed Out, 3 = Boundary
40293	Output Logic	0	1	0	Read/Write	0 = Normal, 1 = Reverse
40294	Annunciator	0	3	0	Read/Write	0 = Off, 1 = Normal, 2 = Reverse, 3 = Flash
40295	Color	0	7	0	Read/Write	0 = No Change, 1 = Green, 2 = Orange, 3 = Red, 4 = Grn/Org, 5 = Red/Org, 6 = Red/Grn, 7 = Line 1 Color
40296	Tracking	0	7	0	Read/Write	0 = No, 1 = S1, 2 = S2, 3 = S3, 4 = S4, 5 = CntLd A, 6 = CntLd B, 7 = CntLd C
40297	Power-up State	0	2	0	Read/Write	0 = Off, 1 = On, 2 = Save
40298	Activation Type	0	1	0	Read/Write	0 = Low Acting, 1 = High Acting
40299	Standby Operation	0	1	0	Read/Write	0 = No, 1 = Yes
40300	Hysteresis	0	59999	0	Read/Write	1 = 1 Display Unit
40301	On Time Delay	0	59999	0	Read/Write	1 = 0.01 Second
40302	Off Time Delay	0	59999	0	Read/Write	1 = 0.01 Second
40303	Output Time-out	0	59999	100	Read/Write	1 = 0.01 Second
40304	Rate Timed Output One-Shot	0	1	0	Read/Write	0 = No, 1 = Yes
40305	Counter Auto Reset	0	4	0	Read/Write	0 = No, 1 = Zero at Start, 2 = CntLd at Start, 3 = Zero at End, 4 = CntLd at End
40306	Output Reset with Counter Reset	0	1	0	Read/Write	0 = No, 1 = Yes
40307	Output Reset at Sn+1	0	2	0	Read/Write	0 = No, 1 = Reset at Sn+1 Start, 2 = Reset at Sn+1 End
	<b>Setpoint 2</b>					
40311	Assignment	0	6	0	Read/Write	0 = None, 1 = Counter A, 2 = Counter B, 3 = Counter C, 4 = Rate A, 5 = Rate B, 6 = Rate C
40312	Action	0	3	0	Read/Write	0 = No, 1 = Latch, 2 = Timed Out, 3 = Boundary
40313	Output Logic	0	1	0	Read/Write	0 = Normal, 1 = Reverse
40314	Annunciator	0	3	0	Read/Write	0 = Off, 1 = Normal, 2 = Reverse, 3 = Flash
40315	Color	0	7	0	Read/Write	0 = No Change, 1 = Green, 2 = Orange, 3 = Red, 4 = Grn/Org, 5 = Red/Org, 6 = Red/Grn, 7 = Line 1 Color
40316	Tracking	0	7	0	Read/Write	0 = No, 1 = S1, 2 = S2, 3 = S3, 4 = S4, 5 = CntLd A, 6 = CntLd B, 7 = CntLd C
40317	Power-up State	0	2	0	Read/Write	0 = Off, 1 = On, 2 = Save
40318	Activation Type	0	1	0	Read/Write	0 = Low Acting, 1 = High Acting
40319	Standby Operation	0	1	0	Read/Write	0 = No, 1 = Yes
40320	Hysteresis	0	59999	0	Read/Write	1 = 1 Display Unit
40321	On Time Delay	0	59999	0	Read/Write	1 = 0.01 Second
40322	Off Time Delay	0	59999	0	Read/Write	1 = 0.01 Second
40323	Output Time-out	0	59999	100	Read/Write	1 = 0.01 Second
40324	Rate Timed Output One-Shot	0	1	0	Read/Write	0 = No, 1 = Yes
40325	Counter Auto Reset	0	4	0	Read/Write	0 = No, 1 = Zero at Start, 2 = CntLd at Start, 3 = Zero at End, 4 = CntLd at End
40326	Output Reset with Counter Reset	0	1	0	Read/Write	0 = No, 1 = Yes
40327	Output Reset at Sn+1	0	2	0	Read/Write	0 = No, 1 = Reset at Sn+1 Start, 2 = Reset at Sn+1 End
	<b>Setpoint 3</b>					
40331	Assignment	0	6	0	Read/Write	0 = None, 1 = Counter A, 2 = Counter B, 3 = Counter C, 4 = Rate A, 5 = Rate B, 6 = Rate C
40332	Action	0	3	0	Read/Write	0 = No, 1 = Latch, 2 = Timed Out, 3 = Boundary
40333	Output Logic	0	1	0	Read/Write	0 = Normal, 1 = Reverse
40334	Annunciator	0	3	0	Read/Write	0 = Off, 1 = Normal, 2 = Reverse, 3 = Flash
40335	Color	0	7	0	Read/Write	0 = No Change, 1 = Green, 2 = Orange, 3 = Red, 4 = Grn/Org, 5 = Red/Org, 6 = Red/Grn, 7 = Line 1 Color
40336	Tracking	0	7	0	Read/Write	0 = No, 1 = S1, 2 = S2, 3 = S3, 4 = S4, 5 = CntLd A, 6 = CntLd B, 7 = CntLd C
40337	Power-up State	0	2	0	Read/Write	0 = Off, 1 = On, 2 = Save
40338	Activation Type	0	1	0	Read/Write	0 = Low Acting, 1 = High Acting
40339	Standby Operation	0	1	0	Read/Write	0 = No, 1 = Yes
40340	Hysteresis	0	59999	0	Read/Write	1 = 1 Display Unit
40341	On Time Delay	0	59999	0	Read/Write	1 = 0.01 Second
40342	Off Time Delay	0	59999	0	Read/Write	1 = 0.01 Second
40343	Output Time-out	0	59999	100	Read/Write	1 = 0.01 Second
40344	Rate Timed Output One-Shot	0	1	0	Read/Write	0 = No, 1 = Yes
40345	Counter Auto Reset	0	4	0	Read/Write	0 = No, 1 = Zero at Start, 2 = CntLd at Start, 3 = Zero at End, 4 = CntLd at End

REGISTER ADDRESS	REGISTER NAME	LOW LIMIT	HIGH LIMIT	FACTORY SETTING	ACCESS	COMMENTS
40346	Output Reset with Counter Reset	0	1	0	Read/Write	0 = No, 1 = Yes
40347	Output Reset at Sn+1	0	2	0	Read/Write	0 = No, 1 = Reset at Sn+1 Start, 2 = Reset at Sn+1 End
	<b>Setpoint 4</b>					
40351	Assignment	0	6	0	Read/Write	0 = None, 1 = Counter A, 2 = Counter B, 3 = Counter C, 4 = Rate A, 5 = Rate B, 6 = Rate C
40352	Action	0	3	0	Read/Write	0 = No, 1 = Latch, 2 = Timed Out, 3 = Boundary
40353	Output Logic	0	1	0	Read/Write	0 = Normal, 1 = Reverse
40354	Annunciator	0	3	0	Read/Write	0 = Off, 1 = Normal, 2 = Reverse, 3 = Flash
40355	Color	0	7	0	Read/Write	0 = No Change, 1 = Green, 2 = Orange, 3 = Red, 4 = Grn/Org, 5 = Red/Org, 6 = Red/Grn, 7 = Line 1 Color
40356	Tracking	0	7	0	Read/Write	0 = No, 1 = S1, 2 = S2, 3 = S3, 4 = S4, 5 = CntLd A, 6 = CntLd B, 7 = CntLd C
40357	Power-up State	0	2	0	Read/Write	0 = Off, 1 = On, 2 = Save
40358	Activation Type	0	1	0	Read/Write	0 = Low Acting, 1 = High Acting
40359	Standby Operation	0	1	0	Read/Write	0 = No, 1 = Yes
40360	Hysteresis	0	59999	0	Read/Write	1 = 1 Display Unit
40361	On Time Delay	0	59999	0	Read/Write	1 = 0.01 Second
40362	Off Time Delay	0	59999	0	Read/Write	1 = 0.01 Second
40363	Output Time-out	0	59999	100	Read/Write	1 = 0.01 Second
40364	Rate Timed Output One-Shot	0	1	0	Read/Write	0 = No, 1 = Yes
40365	Counter Auto Reset	0	4	0	Read/Write	0 = No, 1 = Zero at Start, 2 = CntLd at Start, 3 = Zero at End, 4 = CntLd at End
40366	Output Reset with Counter Reset	0	1	0	Read/Write	0 = No, 1 = Yes
40367	Output Reset at Sn+1	0	2	0	Read/Write	0 = No, 1 = Reset at Sn+1 Start, 2 = Reset at Sn+1 End
	<b>Analog Output</b>					
40371	Type	0	2	1	Read/Write	0 = 0-20 mA, 1 = 4-20 mA, 2 = 0-10 V
40372	Assignment	0	12	0	Read/Write	0 = None, 1 = Counter A, 2 = Counter B, 3 = Counter C, 4 = Rate A, 5 = Rate B, 6 = Rate C, 7 = Hi (max), 8 = Lo (min), 9 = S1, 10 = S2, 11 = S3, 12 = S4
40373	Analog Low Scale Value (Hi word)	-199999	999999	0	Read/Write	Display value that corresponds with 0 V, 0 mA or 4 mA output
40374	Analog Low Scale Value (Lo word)					
40375	Analog High Scale Value (Hi word)	-199999	999999	10000	Read/Write	Display value that corresponds with 10 V or 20 mA output
40376	Analog High Scale Value (Lo word)					
	<b>DISPLAY PARAMETERS</b>					<b>SEE DISPLAY MODULE FOR PARAMETER DESCRIPTIONS</b>
	<b>Line 1</b>					
40381	Line 1 Display Color	0	2	0	Read/Write	0 = Green, 1 = Red, 2 = Orange
40382	Display Intensity Level	1	4	4	Read/Write	1 = Min., 4 = Max.
40383	Display Contrast Level	0	15	7	Read/Write	
40384	Line 1 Display Value Enable	0	255	1	Read/Write	Bit State: 0 = No (Disabled), 1 = Yes (Enabled) Bit 0 = Count A, Bit 1 = Count B, Bit 2 = Count C, Bit 3 = Rate A, Bit 4 = Rate B, Bit 5 = Rate C, Bit 6 = Hi (max), Bit 7 = Lo (min)
40385	Line 1 Display Scroll Enable/Time	0	15	0	Read/Write	0 = No Scroll, 1-15 = Scroll Time in Seconds
40386	Line 1 Units Mnemonic Mode	0	3	3	Read/Write	0 = Off, 1 = Label, 2 = Custom, 3 = Factory
40387	Line 1 Units Mnemonic Digit 1 (Left)	0	57	0	Read/Write	Label Mnemonic Mode only. Active List (A or B). 0 = 9 = i 18 = j 27 = k 36 = l 45 = m(r) 54 = n 1 = R 10 = J 19 = P 28 = Q 37 = G 46 = o 55 = r 2 = b 11 = P 20 = S 29 = I 38 = d 47 = q 56 = o 3 = [ 12 = L 21 = t 30 = z 39 = c 48 = r 57 = . 4 = d 13 = M(l) 22 = U 31 = J 40 = P 49 = u 5 = E 14 = M(r) 23 = V 32 = Y 41 = G 50 = w(r) 6 = F 15 = n 24 = W(l) 33 = S 42 = h 51 = - 7 = G 16 = U 25 = W(r) 34 = B 43 = i 52 = : 8 = H 17 = P 26 = Y 35 = I 44 = n 53 = [
40388	Line 1 Units Mnemonic Digit 2 (Center)	0	57	0	Read/Write	Label Mnemonic Mode only. Active List (A or B).
40389	Line 1 Units Mnemonic Digit 3 (Right)	0	57	0	Read/Write	Label Mnemonic Mode only. Active List (A or B).
	<b>Line 2</b>					
40401	Line 2 Security Code Value	0	250	0	Read/Write	
40402	Line 2 Display Scroll Enable/Time	0	15	0	Read/Write	0 = No Scroll, 1-15 = Scroll Time in Seconds
40403	Line 2 Units Mnemonic Mode	0	7	3	Read/Write	0 = Off, 1 = Label, 2 = Custom, 3 = Factory, 4 = Label & Custom, 5 = Label & Factory, 6 = Line 1 Indexed Label, 7 = Line 1 Indexed Label & Factory
40404	Line 2 Units Mnemonic Digit 1 (Left)	0	54	0	Read/Write	Label Mnemonic Mode. 0 = 9 = i 18 = j 27 = k 36 = l 45 = o 54 = . 1 = R 10 = J 19 = r 28 = I 37 = d 46 = u 2 = b 11 = P 20 = S 29 = z 38 = c 47 = w(r) 3 = [ 12 = L 21 = t 30 = J 39 = P 48 = - 4 = d 13 = M(l) 22 = U 31 = Y 40 = G 49 = : 5 = E 14 = M(r) 23 = W(l) 32 = S 41 = h 50 = [ 6 = F 15 = n 24 = W(r) 33 = B 42 = i 51 = ] 7 = G 16 = U 25 = Y 34 = I 43 = n 52 = r 8 = H 17 = P 26 = z 35 = B 44 = m(r) 53 = o
40405	Line 2 Units Mnemonic Digit 2	0	54	0	Read/Write	Label Mnemonic Mode only. Active List (A or B).

REGISTER ADDRESS	REGISTER NAME	LOW LIMIT	HIGH LIMIT	FACTORY SETTING	ACCESS	COMMENTS
40406	Line 2 Units Mnemonic Digit 3	0	54	0	Read/Write	
40407	Line 2 Units Mnemonic Digit 4	0	54	0	Read/Write	
40408	Line 2 Units Mnemonic Digit 5	0	54	0	Read/Write	
40409	Line 2 Units Mnemonic Digit 6	0	54	0	Read/Write	
40410	Line 2 Units Mnemonic Digit 7	0	54	0	Read/Write	
40411	Line 2 Units Mnemonic Digit 8	0	54	0	Read/Write	
40412	Line 2 Units Mnemonic Digit 9 (Right)	0	54	0	Read/Write	
40413	Line 2 Counter A Display Access	0	2	0	Read/Write	0=LOC, 1=d-rEAd, 2=d-rSt
40414	Line 2 Counter B Display Access	0	2	0	Read/Write	0=LOC, 1=d-rEAd, 2=d-rSt
40415	Line 2 Counter C Display Access	0	2	0	Read/Write	0=LOC, 1=d-rEAd, 2=d-rSt
40416	Line 2 Rate A Display Access	0	2	0	Read/Write	0=LOC, 1=d-rEAd
40417	Line 2 Rate B Display Access	0	2	0	Read/Write	0=LOC, 1=d-rEAd
40418	Line 2 Rate C Display Access	0	2	0	Read/Write	0=LOC, 1=d-rEAd
40419	Line 2 Max (Hi) Value Access	0	2	0	Read/Write	0=LOC, 1=d-rEAd, 2=d-rSt
40420	Line 2 Min (Lo) Value Access	0	2	0	Read/Write	0=LOC, 1=d-rEAd, 2=d-rSt
40421	Line 2 List A/B Selection Access	0	5	0	Read/Write	0=LOC, 1=d-rEAd, 2=d-Entr, 3=P-rEAd, 4=P-Entr, 5=HidE
40422	List A/B Parameter Assignment	0	15	0	Read/Write	Selects List A/B Parameter values (Bit State: 0 = No, 1 = Yes): Bit 3 = Units Mnemonics
40423	Line 2 Setpoint 1 Value Access	0	5	0	Read/Write	0=LOC, 1=d-rEAd, 2=d-Entr, 3=P-rEAd, 4=P-Entr, 5=HidE
40424	Line 2 Setpoint 2 Value Access	0	5	0	Read/Write	0=LOC, 1=d-rEAd, 2=d-Entr, 3=P-rEAd, 4=P-Entr, 5=HidE
40425	Line 2 Setpoint 3 Value Access	0	5	0	Read/Write	0=LOC, 1=d-rEAd, 2=d-Entr, 3=P-rEAd, 4=P-Entr, 5=HidE
40426	Line 2 Setpoint 4 Value Access	0	5	0	Read/Write	0=LOC, 1=d-rEAd, 2=d-Entr, 3=P-rEAd, 4=P-Entr, 5=HidE
40427	Line 2 Scale Factor A Display Access	0	2	0	Read/Write	0=LOC, 1=P-rEAd, 2=P-Entr, 3=HidE
40428	Line 2 Scale Factor B Display Access	0	2	0	Read/Write	0=LOC, 1=P-rEAd, 2=P-Entr, 3=HidE
40429	Line 2 Scale Factor C Display Access	0	2	0	Read/Write	0=LOC, 1=P-rEAd, 2=P-Entr, 3=HidE
40430	Line 2 Count Load A Display Access	0	2	0	Read/Write	0=LOC, 1=P-rEAd, 2=P-Entr, 3=HidE
40431	Line 2 Count Load B Display Access	0	2	0	Read/Write	0=LOC, 1=P-rEAd, 2=P-Entr, 3=HidE
40432	Line 2 Count Load C Display Access	0	2	0	Read/Write	0=LOC, 1=P-rEAd, 2=P-Entr, 3=HidE
40433	Line 2 Display Color Access	0	3	0	Read/Write	0=LOC, 1=P-rEAd, 2=P-Entr, 3=HidE
40434	Line 2 Display Intensity Level Access	0	3	0	Read/Write	0=LOC, 1=P-rEAd, 2=P-Entr, 3=HidE
40435	Line 2 Display Contrast Level Access	0	3	0	Read/Write	0=LOC, 1=P-rEAd, 2=P-Entr, 3=HidE
	<b>Line 2 User Function Access</b>					
40451	Reset Line 1 Function Access	0	2	0	Read/Write	0=LOC, 1=P-Entr, 2=HidE
40452	Reset Counter A Function Access	0	2	0	Read/Write	0=LOC, 1=P-Entr, 2=HidE
40453	Reset Counter B Function Access	0	2	0	Read/Write	0=LOC, 1=P-Entr, 2=HidE
40454	Reset Counter C Function Access	0	2	0	Read/Write	0=LOC, 1=P-Entr, 2=HidE
40455	Reset Counter A,B,C Function Access	0	2	0	Read/Write	0=LOC, 1=P-Entr, 2=HidE
40456	Reset Max (Hi) Function Access	0	2	0	Read/Write	0=LOC, 1=P-Entr, 2=HidE
40457	Reset Min (Lo) Function Access	0	2	0	Read/Write	0=LOC, 1=P-Entr, 2=HidE
40458	Reset Max & Min Function Access	0	2	0	Read/Write	0=LOC, 1=P-Entr, 2=HidE
40459	Print Request Function Access	0	2	0	Read/Write	0=LOC, 1=P-Entr, 2=HidE
	<b>PORT PARAMETERS</b>					<b>SEE PORT MODULE FOR PARAMETER DESCRIPTIONS</b>
	<b>USB</b>					
40481	USB Configuration	0	1	0	Read/Write	0 = Automatic, 1 = Serial
	<b>Serial</b>					
40482	Type	0	2	2	Read/Write	0 = RLC Protocol (ASCII), 1 = Modbus RTU, 2 = Modbus ASCII
40483	Baud Rate	0	5	5	Read/Write	0=1200, 1=2400, 2=4800, 3=9600, 4=19200, 5=38400
40484	Data Bits	0	1	1	Read/Write	0 = 7 Bits, 1 = 8 Bits
40485	Parity	0	2	0	Read/Write	0 = None, 1 = Even, 2 = Odd
40486	Address	0 1	99 247	247	Read/Write	RLC Protocol: 0-99 Modbus: 1-247
40487	Transmit Delay	0	250	10	Read/Write	1 = 0.001 Seconds
40488	Abbreviated Transmission (RLC only)	0	1	0	Read/Write	0 = No, 1 = Yes (Not used with Modbus communications type)
40489	Print Options (RLC only)	0	2047	1	Read/Write	0 = No, 1 = Yes (Not used with Modbus communications type) Bit 0 = Count A, Bit 1 = Count B, Bit 2 = Count C, Bit 3 = Rate A, Bit 4 = Rate B, Bit 5 = Rate C, Bit 6 = Hi (max), Bit 7 = Lo (min), Bit 8 = Scale Factors, Bit 9 = Count Load Values, Bit 10 = Setpoint Values
40490	Load Serial Settings	0	1	0	Read/Write	Changing 40481-40487 will not update the PAX2 until this register is written with a 1. After the write, the communicating device must be changed to new PAX2 settings and this register returns to 0.
	<b>DISPLAY SELECTION</b>					

REGISTER ADDRESS		REGISTER NAME	LOW LIMIT	HIGH LIMIT	FACTORY SETTING	ACCESS	COMMENTS
40504		Line 1 Display (Top Line)	0	8	1	Read/Write	0 = No Display, 1 = Count A, 2 = Count B, 3 = Count C, 4 = Rate A, 5 = Rate B, 6 = Rate C, 7 = Max (Hi), 8 = Min (Lo)
40505		Line 2 Display (Bottom Line)	0	13	0	Read/Write	0 = No Display, 1 = Count A, 2 = Count B, 3 = Count C, 4 = Rate A, 5 = Rate B, 6 = Rate C, 7 = Max (Hi), 8 = Min (Lo), 9 = List A/B, 10 = S1, 11 = S2, 12 = S3, 13 = S4
<b>UNITS MNEMONICS</b>							
List A	List B	<b>Line 1 Units Label Mode (A/B List)</b>					<b>SEE USER LIST FUNCTION IN INPUT MODULE FOR DETAILS</b>
40601	40801	Line 1 Units Mnemonic Digit 1 (Left)	0	57	0	Read/Write	Label Mnemonic Mode only. Active List (A or B). 0 = 9 = i 18 = j 27 = k 36 = l 45 = m(r) 54 = n 1 = p 10 = q 19 = r 28 = s 37 = t 46 = u 55 = v 2 = w 11 = x 20 = y 29 = z 38 = aa 47 = ab 56 = ac 3 = ad 12 = ae 21 = af 30 = ag 39 = ah 48 = ai 57 = aj 4 = ak 13 = al(l) 22 = am 31 = an 40 = ao 49 = ap 5 = ar 14 = as(r) 23 = at 32 = au 41 = av 50 = aw(r) 6 = ax 15 = ay 24 = az(l) 33 = ba 42 = bb 51 = bc 7 = bd 16 = be 25 = bf(r) 34 = bg 43 = bh 52 = bi 8 = bj 17 = bk 26 = bl 35 = bm 44 = bn 53 = bo
40602	40802	Line 1 Units Mnemonic Digit 2	0	57	0	Read/Write	
40603	40803	Line 1 Units Mnemonic Digit 3 (Right)	0	57	0	Read/Write	
List A	List B	<b>Line 1 Units Custom Mode (A/B List)</b>					
40604	40804	Counter A Mnemonic - Digit 1 (Left)	0	57	0	Read/Write	Custom Mnemonic Mode.
40605	40805	Counter A Mnemonic - Digit 2 (Center)	0	57	0	Read/Write	
40606	40806	Counter A Mnemonic - Digit 3 (Right)	0	57	0	Read/Write	
40607	40807	Counter B Mnemonic - Digit 1	0	57	0	Read/Write	
40608	40808	Counter B Mnemonic - Digit 2	0	57	0	Read/Write	
40609	40809	Counter B Mnemonic - Digit 3	0	57	0	Read/Write	
40610	40810	Counter C Mnemonic - Digit 1	0	57	0	Read/Write	
40611	40811	Counter C Mnemonic - Digit 2	0	57	0	Read/Write	
40612	40812	Counter C Mnemonic - Digit 3	0	57	0	Read/Write	
40613	40813	Rate A Mnemonic - Digit 1	0	57	0	Read/Write	
40614	40814	Rate A Mnemonic - Digit 2	0	57	0	Read/Write	
40615	40815	Rate A Mnemonic - Digit 3	0	57	0	Read/Write	
40616	40816	Rate B Mnemonic - Digit 1	0	57	0	Read/Write	
40617	40817	Rate B Mnemonic - Digit 2	0	57	0	Read/Write	
40618	40818	Rate B Mnemonic - Digit 3	0	57	0	Read/Write	
40619	40819	Rate C Mnemonic - Digit 1	0	57	0	Read/Write	
40620	40820	Rate C Mnemonic - Digit 2	0	57	0	Read/Write	
40621	40821	Rate C Mnemonic - Digit 3	0	57	0	Read/Write	
40622	40822	Max (Hi) Mnemonic - Digit 1	0	57	0	Read/Write	
40623	40823	Max (Hi) Mnemonic - Digit 2	0	57	0	Read/Write	
40624	40824	Max (Hi) Mnemonic - Digit 3	0	57	0	Read/Write	
40625	40825	Min (Lo) Mnemonic - Digit 1	0	57	0	Read/Write	
40626	40826	Min (Lo) Mnemonic - Digit 2	0	57	0	Read/Write	
40627	40827	Min (Lo) Mnemonic - Digit 3	0	57	0	Read/Write	
List A	List B	<b>Line 2 Units Label Mode (A/B List)</b>					
40628	40828	Line 2 Units Mnemonic Digit 1 (Left)	0	54	0	Read/Write	Label Mnemonic Mode. 0 = 9 = i 18 = j 27 = k 36 = l 45 = m 54 = n 1 = p 10 = q 19 = r 28 = s 37 = t 46 = u 2 = v 11 = w 20 = x 29 = y 38 = z 47 = aa(r) 3 = ab 12 = ac 21 = ad 30 = ae 39 = af 48 = ag 4 = ah 13 = ai(l) 22 = aj 31 = ak 40 = al 49 = am 5 = an 14 = ao(r) 23 = ap(l) 32 = aq 41 = ar 50 = as 6 = at 15 = au 24 = av(r) 33 = aw 42 = ax 51 = ay 7 = az 16 = ba 25 = bb 34 = bc 43 = bd 52 = be 8 = bf 17 = bg 26 = bh 35 = bi 44 = bj(r) 53 = bk
40629	40829	Line 2 Units Mnemonic Digit 2	0	54	0	Read/Write	
40630	40830	Line 2 Units Mnemonic Digit 3	0	54	0	Read/Write	
40631	40831	Line 2 Units Mnemonic Digit 4	0	54	0	Read/Write	
40632	40832	Line 2 Units Mnemonic Digit 5	0	54	0	Read/Write	
40633	40833	Line 2 Units Mnemonic Digit 6	0	54	0	Read/Write	
40634	40834	Line 2 Units Mnemonic Digit 7	0	54	0	Read/Write	
40635	40835	Line 2 Units Mnemonic Digit 8	0	54	0	Read/Write	
40636	40836	Line 2 Units Mnemonic Digit 9 (Right)	0	54	0	Read/Write	
List A	List B	<b>Line 2 Units Custom Mode (A/B List)</b>					
40637	40837	Counter A Mnemonic - Digit 1 (Left)	0	54	0	Read/Write	Custom Mnemonic Mode.
40638	40838	Counter A Mnemonic - Digit 2	0	54	0	Read/Write	
40639	40839	Counter A Mnemonic - Digit 3	0	54	0	Read/Write	
40640	40840	Counter A Mnemonic - Digit 4	0	54	0	Read/Write	
40641	40841	Counter A Mnemonic - Digit 5	0	54	0	Read/Write	
40642	40842	Counter A Mnemonic - Digit 6	0	54	0	Read/Write	



REGISTER ADDRESS	REGISTER NAME	LOW LIMIT	HIGH LIMIT	FACTORY SETTING	ACCESS	COMMENTS
40643	40843	Counter A Mnemonic - Digit 7	0	54	0	Read/Write
40644	40844	Counter A Mnemonic - Digit 8	0	54	0	Read/Write
40645	40845	Counter A Mnemonic - Digit 9 (Right)	0	54	0	Read/Write
40646	40846	Counter B Mnemonic - Digit 1	0	54	0	Read/Write
40647	40847	Counter B Mnemonic - Digit 2	0	54	0	Read/Write
40648	40848	Counter B Mnemonic - Digit 3	0	54	0	Read/Write
40649	40849	Counter B Mnemonic - Digit 4	0	54	0	Read/Write
40650	40850	Counter B Mnemonic - Digit 5	0	54	0	Read/Write
40651	40851	Counter B Mnemonic - Digit 6	0	54	0	Read/Write
40652	40852	Counter B Mnemonic - Digit 7	0	54	0	Read/Write
40653	40853	Counter B Mnemonic - Digit 8	0	54	0	Read/Write
40654	40854	Counter B Mnemonic - Digit 9	0	54	0	Read/Write
40655	40855	Counter C Mnemonic - Digit 1	0	54	0	Read/Write
40656	40856	Counter C Mnemonic - Digit 2	0	54	0	Read/Write
40657	40857	Counter C Mnemonic - Digit 3	0	54	0	Read/Write
40658	40858	Counter C Mnemonic - Digit 4	0	54	0	Read/Write
40659	40859	Counter C Mnemonic - Digit 5	0	54	0	Read/Write
40660	40860	Counter C Mnemonic - Digit 6	0	54	0	Read/Write
40661	40861	Counter C Mnemonic - Digit 7	0	54	0	Read/Write
40662	40862	Counter C Mnemonic - Digit 8	0	54	0	Read/Write
40663	40863	Counter C Mnemonic - Digit 9	0	54	0	Read/Write
40664	40864	Rate A Mnemonic - Digit 1	0	54	0	Read/Write
40665	40865	Rate A Mnemonic - Digit 2	0	54	0	Read/Write
40666	40866	Rate A Mnemonic - Digit 3	0	54	0	Read/Write
40667	40867	Rate A Mnemonic - Digit 4	0	54	0	Read/Write
40668	40868	Rate A Mnemonic - Digit 5	0	54	0	Read/Write
40669	40869	Rate A Mnemonic - Digit 6	0	54	0	Read/Write
40670	40870	Rate A Mnemonic - Digit 7	0	54	0	Read/Write
40671	40871	Rate A Mnemonic - Digit 8	0	54	0	Read/Write
40672	40872	Rate A Mnemonic - Digit 9	0	54	0	Read/Write
40673	40873	Rate B Mnemonic - Digit 1	0	54	0	Read/Write
40674	40874	Rate B Mnemonic - Digit 2	0	54	0	Read/Write
40675	40875	Rate B Mnemonic - Digit 3	0	54	0	Read/Write
40676	40876	Rate B Mnemonic - Digit 4	0	54	0	Read/Write
40677	40877	Rate B Mnemonic - Digit 5	0	54	0	Read/Write
40678	40878	Rate B Mnemonic - Digit 6	0	54	0	Read/Write
40679	40879	Rate B Mnemonic - Digit 7	0	54	0	Read/Write
40680	40880	Rate B Mnemonic - Digit 8	0	54	0	Read/Write
40681	40881	Rate B Mnemonic - Digit 9	0	54	0	Read/Write
40682	40882	Rate C Mnemonic - Digit 1	0	54	0	Read/Write
40683	40883	Rate C Mnemonic - Digit 2	0	54	0	Read/Write
40684	40884	Rate C Mnemonic - Digit 3	0	54	0	Read/Write
40685	40885	Rate C Mnemonic - Digit 4	0	54	0	Read/Write
40686	40886	Rate C Mnemonic - Digit 5	0	54	0	Read/Write
40687	40887	Rate C Mnemonic - Digit 6	0	54	0	Read/Write
40688	40888	Rate C Mnemonic - Digit 7	0	54	0	Read/Write
40689	40889	Rate C Mnemonic - Digit 8	0	54	0	Read/Write
40690	40890	Rate C Mnemonic - Digit 9	0	54	0	Read/Write
40691	40891	Max (Hi) Mnemonic - Digit 1	0	54	0	Read/Write
40692	40892	Max (Hi) Mnemonic - Digit 2	0	54	0	Read/Write
40693	40893	Max (Hi) Mnemonic - Digit 3	0	54	0	Read/Write
40694	40894	Max (Hi) Mnemonic - Digit 4	0	54	0	Read/Write
40695	40895	Max (Hi) Mnemonic - Digit 5	0	54	0	Read/Write
40696	40896	Max (Hi) Mnemonic - Digit 6	0	54	0	Read/Write
40697	40897	Max (Hi) Mnemonic - Digit 7	0	54	0	Read/Write
40698	40898	Max (Hi) Mnemonic - Digit 8	0	54	0	Read/Write
40699	40899	Max (Hi) Mnemonic - Digit 9	0	54	0	Read/Write
40700	40900	Min (Lo) Mnemonic - Digit 1	0	54	0	Read/Write
40701	40901	Min (Lo) Mnemonic - Digit 2	0	54	0	Read/Write
40702	40902	Min (Lo) Mnemonic - Digit 3	0	54	0	Read/Write
40703	40903	Min (Lo) Mnemonic - Digit 4	0	54	0	Read/Write
40704	40904	Min (Lo) Mnemonic - Digit 5	0	54	0	Read/Write
40705	40905	Min (Lo) Mnemonic - Digit 6	0	54	0	Read/Write
40706	40906	Min (Lo) Mnemonic - Digit 7	0	54	0	Read/Write
40707	40907	Min (Lo) Mnemonic - Digit 8	0	54	0	Read/Write

REGISTER ADDRESS	REGISTER NAME	LOW LIMIT	HIGH LIMIT	FACTORY SETTING	ACCESS	COMMENTS
40708   40908	Min (Lo) Mnemonic - Digit 9	0	54	0	Read/Write	
41001-41010	Slave ID	N/A	N/A	N/A	Read Only	RLC-PAX2D <a><b><0100h><0040h><0040h><0010h> <a> = SP Card Status. "0"-No Card, "2"-Dual SP, "4"-Quad SP <b> = Linear Card Status. "0"-Not Installed, "1"-Installed <0100h> = Version Number (1.00 or higher) <0040h><0040h> = 64 Register Writes/Reads (Max.) <0010h> = 16 Register GUID/Scratch
41101-41116	GUID/Scratch	N/A	N/A	N/A	Read/Write	Reserved (may be used in future RLC software)

## SERIAL RLC PROTOCOL COMMUNICATIONS

RLC Communications requires the Serial Communications Type Parameter (*TYPE*) be set to RLC Protocol (*RLC*).

### SENDING SERIAL COMMANDS AND DATA TO THE METER

When sending commands to the meter, a string containing at least one command character must be constructed. A command string consists of a command character, a value identifier, numerical data (if writing data to the meter) followed by a command terminator character \* or \$. The <CR> is also available as a terminator when Counter C is in the SLAVE mode.

#### Command Chart

COMMAND	DESCRIPTION	NOTES
N	Node (Meter) Address Specifier	Address a specific meter. Must be followed by a two digit node address. Not required when address = 00.
T	Transmit Value (read)	Read a register from the meter. Must be followed by register ID character
V	Value Change (write)	Write to register of the meter. Must be followed by register ID character and numeric data.
R	Reset	Reset a register or output. Must be followed by register ID character.
P	Block Print Request	Initiates a block print output. Registers are defined in programming.

#### Command String Construction

The command string must be constructed in a specific sequence. The meter does not respond with an error message to invalid commands. The following procedure details construction of a command string:

- The first characters consist of the Node Address Specifier (N) followed by a 1 or 2 character address number. The address number of the meter is programmable. If the node address is 0, this command and the node address itself may be omitted. For node address 1 through 9, a leading zero character is not required. (The only exception is a numeric transmission when Counter C is set for slave mode.) This is the only command that may be used in conjunction with other commands.
- After the optional address specifier, the next character is the command character.
- The next character is the Register ID. This identifies the register that the command affects. The P command does not require a Register ID character. It prints according to the selections made in print options.
- If constructing a value change command (writing data), the numeric data is sent next.
- All command strings must be terminated with the string termination characters \*, \$ or when Counter C is set for slave mode <CR>. The meter does not begin processing the command string until this character is received. See Timing Diagram figure for differences between terminating characters.

#### Sending Numeric Data

Numeric data sent to the meter must be limited to the digit range shown under transmit details in the Register Identification Chart. Leading zeros are ignored. Negative numbers must have a minus sign. The meter ignores any decimal point and conforms the number to the scaled resolution. (For example: the meter's scaled decimal point position = 0.0 and 25 is written to a register. The value of the register is now 2.5.)

*Note: Since the meter does not issue a reply to value change commands, follow with a transmit value command for readback verification.*

#### Register Identification Chart

ID	VALUE DESCRIPTION	MNEMONIC	COMMAND	TRANSMIT DETAILS
A	Count A	CTA	T, V, R	9 positive, 8 ½ negative
B	Count B	CTB	T, V, R	9 positive, 8 ½ negative
C	Count C	CTC	T, V, R	9 positive, 8 ½ negative
D	Rate A	RTA	T	6 digit, positive only
E	Rate B	RTB	T	6 digit, positive only
F	Rate C	RTC	T	6 positive, 5 ½ negative
G	Max (Hi) Value	MAX	T, V, R	6 positive, 5 ½ negative
H	Min (Lo) Value	MIN	T, V, R	6 positive, 5 ½ negative
I	Scale Factor A	SFA	T, V	6 digit, positive only
J	Scale Factor B	SFB	T, V	6 digit, positive only
K	Counter Load A	CLA	T, V	6 positive, 5 ½ negative
L	Counter Load B	CLB	T, V	6 positive, 5 ½ negative
M	Setpoint 1	SP1	T, V, R	6 positive, 5 ½ negative
O	Setpoint 2	SP2	T, V, R	6 positive, 5 ½ negative
Q	Setpoint 3	SP3	T, V, R	6 positive, 5 ½ negative
S	Setpoint 4	SP4	T, V, R	6 positive, 5 ½ negative
U	Auto/Manual Register	MMR	T, V	0 – auto, 1 - manual
W	Analog Output Register	AOR	T, V	0 – 4095 normalized
X	Setpoint Register	SOR	T, V	0 – not active, 1 – active

#### Command String Examples:

- Address = 17, Write 350 to Setpoint 1.  
String: N17VM350\$
- Address = 5, Read Count A value.  
String: N5TA\*
- Address = 0, Reset Setpoint 4 output.  
String: RS\*

#### RECEIVING DATA FROM THE METER

Data is transmitted by the meter in response to either a transmit command (T), a print block command (P) or User Function print request. The response from the meter is either a full field transmission or an abbreviated transmission. The meter response mode is selected in Serial Port Parameters (*ABRU*).

#### Full Field Transmission (Address, Mnemonic, Numeric data)

Byte	Description
1, 2	2 byte Node (meter) Address field [00-99]
3	<SP> (Space)
4-6	3 byte Register Mnemonic field
7-18	12 byte data field, 10 bytes for number, one byte for sign, one byte for decimal point
19	<CR> carriage return
20	<LF> line feed
21	<SP>* (Space)
22	<CR>* carriage return
23	<LF>* line feed

\* These characters only appear in the last line of a block print.

The first two characters transmitted are the node address, unless the node address assigned = 0, in which case spaces are substituted. A space follows the node address field. The next three characters are the register mnemonic.

The numeric data is transmitted next. The numeric field is 12 characters long (to accommodate the 10 digit totalizer), with the decimal point position floating

within the data field. Negative values have a leading minus sign. The data field is right justified with leading spaces.

The end of the response string is terminated with a carriage return <CR> and <LF>. When block print is finished, an extra <SP><CR> <LF> is used to provide separation between the blocks.

### Abbreviated Transmission (Numeric data only)

Byte	Description
1-12	12 byte data field, 10 bytes for number, one byte for sign, one byte for decimal point
13	<CR> carriage return
14	<LF> line feed
15	<SP>* (Space)
16	<CR>* carriage return
17	<LF>* line feed

\* These characters only appear in the last line of a block print.

### Meter Response Examples:

- Address = 17, full field response, Count A = 875  
17 CTA 875 <CR><LF>
- Address = 0, full field response, Setpoint 2 = -250.5  
SP2 -250.5<CR><LF>
- Address = 0, abbreviated response, Setpoint 2 = 250, last line of block print  
250<CR><LF><SP><CR><LF>

### Auto/Manual Mode Register (MMR) ID: U

This register sets the controlling mode for the outputs. In Auto Mode (0) the meter controls the setpoint and analog output. In Manual Mode (1) the outputs are defined by the registers SOR and AOR. When transferring from auto mode to manual mode, the meter holds the last output value (until the register is changed by a write). Each output may be independently changed to auto or manual. In a write command string (VU), any character besides 0 or 1 in a field will not change the corresponding output mode.

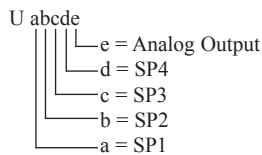

**Example:** VU00011\* places SP4 and Analog in manual.

### Analog Output Register (AOR) ID: W

This register stores the present signal value of the analog output. The range of values of this register is 0 to 4095, which corresponds to the analog output range per the following chart:

Register Value	Output Signal*		
	0-20 mA	4-20 mA	0-10 V
0	0.00	4.00	0.000
1	0.005	4.004	0.0025
2047	10.000	12.000	5.000
4094	19.995	19.996	9.9975
4095	20.000	20.000	10.000

\*Due to the absolute accuracy rating and resolution of the output card, the actual output signal may differ 0.15% FS from the table values. The output signal corresponds to the range selected (0-20 mA, 4-20 mA or 0-10 V).

Writing to this register (VW) while the analog output is in the Manual Mode causes the output signal level to update immediately to the value sent. While in the Automatic Mode, this register may be written to, but it has no effect until the analog output is placed in the manual mode. When in the Automatic Mode, the meter controls the analog output signal level. Reading from this register (TW) will show the present value of the analog output signal.

**Example:** VW2047 will result in an output of 10.000 mA, 12.000 mA or 5.000V depending on the range selected.

### Setpoint Output Register (SOR) ID: X

This register stores the states of the setpoint outputs. Reading from this register (TX) will show the present state of all the setpoint outputs. A "0" in the setpoint location means the output is off and a "1" means the output is on.

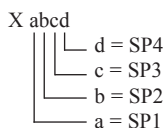

In Automatic Mode, the meter controls the setpoint output state. In Manual Mode, writing to this register (VX) will change the output state. Sending any character besides 0 or 1 in a field or if the corresponding output was not first in manual mode, the corresponding output value will not change. (It is not necessary to send least significant 0s.)

**Example:** VX10\* will result in output 1 on and output 2 off.

## COUNTER C SERIAL SLAVE DISPLAY

Counter C may be programmed for *SLAVE* to act as a serial slave display. In this mode, the carriage return <CR> is added as a valid command terminator character for all serial command strings. The <CR> as a terminator may be very useful for standard serial commands, even if Counter C is never displayed or sent a slave message. The <\*> and <\$> are also recognized as valid terminators for the serial slave.

The Counter C slave display is right aligned, and has the capacity of displaying six characters on Line 1 or nine characters on Line 2. When less than the full display of characters is received, blank spaces are placed in front of the characters. If more than the full display of characters is received, only the last six (or nine) characters are displayed. The meter has an internal 300 character buffer for the slave display. If more than 300 characters are received, the additional characters are discarded until a <CR> is received. At that point, the last six (or nine) characters in the buffer are displayed.

Counter C processes Numeric and Literal slave transmissions as follows.

### Numeric Transmissions

When a string that does not begin with #, T, V, P or R is received, the meter processes it as a Numeric transmission. In this case, only numbers and a minus sign can be displayed. All other characters in the string are discarded. If a minus sign appears anywhere in the string the resulting number will be negative. If a decimal point is desired, it is programmed in Counter C setup and is ignored in the serial string. If no numerical characters are received, then the numeric value will be zero.

The numeric display can be used for setpoint (boundary action only) and analog output functions. The numeric value is retained in Counter C memory until another Numeric transmission is received. If a numeric values is not to be saved to non-volatile memory, send the value as a literal transmission.

*Note: Numeric transmissions sent to meter addresses 1 through 9 must have a leading zero character sent with the address (i.e. N01 through N09).*

### Literal Transmissions

When a string that begins with # is received, the meter processes it as a Literal transmission. In this case, only numeric and alphabetic characters or a minus sign (dash) will be processed. Any other non-alphanumeric character will be discarded. Non-displayable alphabetic characters (M, W and X) will be replaced with a space. A Literal display overrides any Units Mnemonics characters, when shown on Line 2.

A Literal display will replace a Numeric value in the Counter C display. However, it will not remove a previous Numeric value from Counter C memory or prevent the Counter C assigned outputs from functioning with the previous Numeric value.

Displayable Alphabetic Characters:

ASCII	A	B	C	D	E	F	G	H	I	J	K	L	N	O	P	Q	R	S	T	U	V	Y	Z
DISPLAY	A	B	C	D	E	F	G	H	I	J	K	L	N	O	P	Q	R	S	T	U	V	Y	Z

(Both uppercase and lowercase ASCII characters are accepted.)

### Downloading Data from a G3 to a PAX2D

Communications:

Port: RS232 Comms Raw Serial Port  
Port Driver: <system> Raw Serial Port

Programming:

PortPrint(2, "N01" + IntToText(Var1, 10, 6) + "r");

This program is called from the Global On Tick. It sends "N01" (the meter address), followed by the ASCII equivalent of Var1, then a carriage return.

## COMMAND RESPONSE TIME

The meter can only receive data or transmit data at any one time (half-duplex operation). When sending commands and data to the meter, a delay must be imposed before sending another command. This allows enough time for the meter to process the command and prepare for the next command.

At the start of the time interval  $t_1$ , the computer program prints or writes the string to the com port, thus initiating a transmission. During  $t_1$ , the command characters are under transmission and at the end of this period, the command terminating character (\*) is received by the meter. The time duration of  $t_1$  is dependent on the number of characters and baud rate of the channel.

$$t_1 = (10 * \# \text{ of characters}) / \text{baud rate}$$

At the start of time interval  $t_2$ , the meter starts the interpretation of the command and when complete, performs the command function. This time interval  $t_2$  varies from 2 msec to 15 msec. If no response from the meter is expected, the meter is ready to accept another command.

If the meter is to reply with data, the time interval  $t_2$  is controlled by the use of the command terminating character and the Serial Transmit Delay parameter (*dELAY*). The standard command line terminating character is “\*”. This terminating character results in a response time window of the Serial Transmit Delay time (*dELAY*) plus 15 msec. maximum. The *dELAY* parameter should be programmed to a value that allows sufficient time for the release of the sending driver on the RS485 bus. Terminating the command line with “\$” results in a response time window ( $t_2$ ) of 2 msec minimum and 15 msec maximum. The response time of this terminating character requires that sending drivers release within 2 msec after the terminating character is received.

At the beginning of time interval  $t_3$ , the meter responds with the first character of the reply. As with  $t_1$ , the time duration of  $t_3$  is dependent on the number of characters and baud rate of the channel.

$$t_3 = (10 * \# \text{ of characters}) / \text{baud rate}$$

At the end of  $t_3$ , the meter is ready to receive the next command. The maximum serial throughput of the meter is limited to the sum of the times  $t_1$ ,  $t_2$  and  $t_3$ .

## Timing Diagrams

### NO REPLY FROM METER

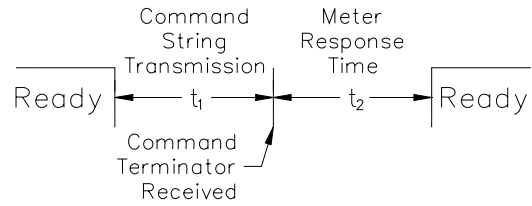

### RESPONSE FROM METER

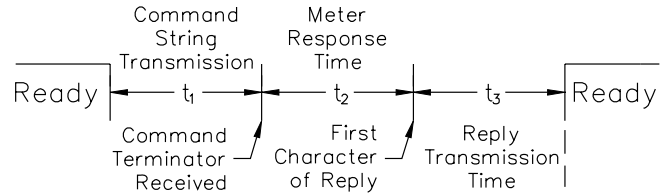

## COMMUNICATION FORMAT

Data is transferred from the meter through a serial communication channel. In serial communications, the voltage is switched between a high and low level at a predetermined rate (baud rate) using ASCII encoding. The receiving device reads the voltage levels at the same intervals and then translates the switched levels back to a character.

The voltage level conventions depend on the interface standard. The table lists the voltage levels for each standard.

LOGIC	INTERFACE STATE	RS232*	RS485*
1	mark (idle)	TXD,RXD; -3 to -15 V	a-b < -200 mV
0	space (active)	TXD,RXD; +3 to +15 V	a-b > +200 mV

\* Voltage levels at the Receiver

Data is transmitted one byte at a time with a variable idle period between characters (0 to ∞). Each ASCII character is “framed” with a beginning start bit, an optional parity bit and one or more ending stop bits. The data format and baud rate must match that of other equipment in order for communication to take place. The figures list the data formats employed by the meter.

### Start bit and Data bits

Data transmission always begins with the start bit. The start bit signals the receiving device to prepare for reception of data. One bit period later, the least significant bit of the ASCII encoded character is transmitted, followed by the remaining data bits. The receiving device then reads each bit position as they are transmitted. Since the sending and receiving devices operate at the same transmission speed (baud rate), the data is read without timing errors.

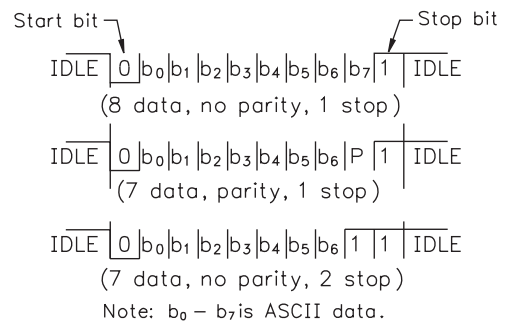

### Character Frame Figure

#### Parity bit

After the data bits, the parity bit is sent. The transmitter sets the parity bit to a zero or a one, so that the total number of ones contained in the transmission (including the parity bit) is either even or odd. This bit is used by the receiver to detect errors that may occur to an odd number of bits in the transmission. However, a single parity bit cannot detect errors that may occur to an even number of bits. Given this limitation, the parity bit is often ignored by the receiving device. The PAX meter ignores the parity bit of incoming data and sets the parity bit to odd, even or none (mark parity) for outgoing data.

#### Stop bit

The last character transmitted is the stop bit. The stop bit provides a single bit period pause to allow the receiver to prepare to re-synchronize to the start of a new transmission (start bit of next byte). The receiver then continuously looks for the occurrence of the start bit. If 7 data bits and no parity is selected, then 2 stop bits are sent from the PAX meter.

# FACTORY SERVICE OPERATIONS (FACTORY)

## FACTORY SERVICE CODE



Enter the Service Code for the desired operation.

## RESTORE FACTORY DEFAULTS



Use the  $\overline{F1}$  and  $\overline{F2}$  keys to display CODE 66 and press **P**. The meter will flash rESEt and then return to CODE 50. Press the **P** key to return to Display Mode. This will overwrite all user settings with the factory settings. The only exception is the User Mnemonics which retain their programmed values (see Code 69).

## RESTORE FACTORY DEFAULTS (w/Units Mnemonics)



Same as Code 66, except the User Mnemonics are also returned to the factory default settings (blank).

## MODEL AND CODE VERSION



The meter will briefly display the model (P2d) on Line 1, and the current firmware version (UEr x.xx) on Line 2, and then return to CODE 50.

## INPUT A AND B LOGIC SELECTION



The Count Inputs A and B are factory configured for falling edge triggered (active low) operation in single edge count modes. The Counter Operating Mode descriptions in the Input programming section reflect this logic. If an application is better suited to use rising edge triggered (active high) operation, the Input Logic for Input A and/or Input B can be changed by entering Code 55.



Selecting HI-Act sets the Input A logic to rising edge triggered (active high) operation. Be advised that all references to Input A falling edge and Input A rising edge will be reversed for the Counter Operating Mode descriptions.



Selecting HI-Act sets the Input B logic to rising edge triggered (active high) operation. Be advised that all references to Input B falling edge and Input B rising edge will be reversed for the Counter Operating Mode descriptions.

## METER CALIBRATION

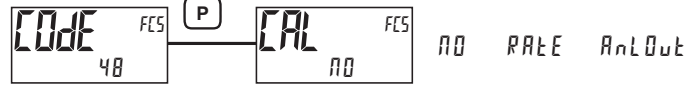

Enter Code 48 and choose Rate or Analog Output calibration.

The only items in the PAX2D meter that can be calibrated are the Rate Indicator accuracy and the Analog Output. The Rate Indicator is scaled in the Rate Input Parameter programming section. The Analog Output signal is scaled in the Analog Output Parameter section. If the Rate display or the Analog Output appears to be indicating incorrectly or inaccurately, refer to the Troubleshooting section to make sure the meter is properly scaled for the application.

If Rate accuracy or Analog Output recalibration is required (generally every 2 years), it should be performed by qualified technicians using appropriate equipment. Calibration does not change any user programmed parameters.

Note: Allow a 30 minute warm-up period before starting calibration.

## Rate Accuracy Calibration



Rate Indicator calibration is done by adjusting the Rate Accuracy Offset value. This value provides a Rate calculation adjustment factor expressed in percent of the display reading. An adjustment range of  $\pm 0.01\%$  is provided, which equals  $\pm 1$  count for a display reading of 10,000.

The initial offset value is set during factory test. To calibrate, connect a precision signal generator with an accuracy of 0.005% or better to Input A on the PAX2D. (Refer to the Rate Input Parameter programming section for Rate setup details.) Using the Rate A Decimal Point position and Scaling Display parameters, program the meter to read the input frequency with maximum display resolution (i.e. 6-digit display reading). Compare the Rate display to the signal generator output frequency. Adjust the Rate Accuracy Offset value higher (for low Display reading) or lower (for high Display Reading) until the Rate display matches the signal generator.

## Analog Output Card Calibration

Before starting, verify that a precision meter with an accuracy of 0.05% or better (voltmeter for voltage output and/or current meter for current output) is connected and ready. Using the chart below, step through the five selections to be calibrated. At each prompt, use the PAX2D  $\overline{F1}$  and  $\overline{F2}$  keys to adjust the output so that the external meter display matches the selection being calibrated. When the external reading matches, or if the range is not being calibrated, press the **P** key to advance to the next range. When all the desired ranges have been calibrated, exit programming mode and remove the external meters.

DISPLAY	EXTERNAL METER	ACTION
0.000A	0.00 mA	Adjust if necessary, press <b>P</b>
0.004A	4.00 mA	Adjust if necessary, press <b>P</b>
0.020A	20.00 mA	Adjust if necessary, press <b>P</b>
0.0V	0.00 V	Adjust if necessary, press <b>P</b>
10.0V	10.00 V	Adjust if necessary, press <b>P</b>

# TROUBLESHOOTING

PROBLEM	REMEDIES
No Display At Power-Up	Check power level and power connections.
Program Locked-Out	Check for Active User Input, programmed for <i>PLUC</i> . Deactivate User Input. Enter proper access code at <i>CODE 0</i> prompt.
No Line 1 Display	Check program settings for Line 1 Display Value Select/Enable. Confirm at least one Line 1 Display Value is enabled ( <i>YES</i> ).
No Line 2 Display	Check program settings for Line 2 Value Access. Confirm at least one Line 2 Parameter Value is enabled in Main Display Loop ( <i>d-rEAd, d-rSt, d-EntEr</i> ).
No Line 1 Units Mnemonic Display	Check program settings for Line 1 Units Mnemonic(s).
Display of <i>OUER</i> or <i>UndEr</i>	Value exceeds Display capacity of the meter. See Display Messages in Meter Specifications.
Incorrect Display Value or Not Counting	Check Input wiring, DIP switch setting, Input programming, Scale Factor calculation, Input signal level, User Input Logic setting, lower input signal frequency.
User Input Not Functioning	Check User Input wiring, User Logic setting, User Function settings, User Input being used as a signal input in dual count modes (see Counter Operating Modes).
Modules or Parameters Not Accessible	Check for corresponding plug-in option card. Verify parameter is valid in regard to previous program settings.
Error Code: <i>Er r KE Y</i>	Keypad is active at power up. Check for depressed or stuck keypad. Press any key to clear Error Code.
Error Code: <i>EE PAR</i> Error Code: <i>EE Pdn</i>	Parameter Data Checksum Error. Press any key to clear Error Code, verify all program settings and cycle power. Contact factory if Error Code returns at next power-up.
Error Code: <i>Er r P r a</i>	Parameter Data Validation Error. Press any key to clear Error Code, verify all program settings and cycle power. Contact factory if Error Code returns at next power-up.
Error Code: <i>EE Lin</i>	Linear Output Card Data Validation Error. Press any key to clear Error Code and cycle power. If Error Code returns at next power-up, replace Linear Option Card or contact factory.

## PARAMETER VALUE CHART PAX2D

Programmer \_\_\_\_\_ Date \_\_\_\_\_  
Meter# \_\_\_\_\_ Security Code \_\_\_\_\_

### INPUT INPUT SETUP PARAMETERS

#### COUNT Counter Parameters

DISPLAY	PARAMETER	USER SETTING	DISPLAY	PARAMETER	USER SETTING
<b>COUNTER A PARAMETERS</b>			<i>dEC Pt</i>	Rate A Decimal Position	_____
<i>Ent A</i>	Counter A Operating Mode	_____	<i>SC PtS</i>	Rate A Scaling Points	_____
<i>dEC Pt</i>	Counter A Decimal Position	_____	<i>RR dSP 1</i>	Rate A Scaling Point 1 Display	_____
<i>SC FAc</i>	Counter A Scale Factor	_____	<i>RR INP 1</i>	Rate A Scaling Point 1 Input	_____
<i>SCALEr</i>	Counter A Scale Multiplier	_____	<i>RR dSP 2</i>	Rate A Scaling Point 2 Display	_____
<i>RESEt</i>	Counter A Reset Action	_____	<i>RR INP 2</i>	Rate A Scaling Point 2 Input	_____
<i>Ent Ld</i>	Counter A Count Load Value	_____	<i>RR dSP 3</i>	Rate A Scaling Point 3 Display	_____
<i>R P-UP</i>	Counter A Reset At Power-Up	_____	<i>RR INP 3</i>	Rate A Scaling Point 3 Input	_____
<i>PS Out</i>	Prescaler Output Enable	_____	<i>RR dSP 4</i>	Rate A Scaling Point 4 Display	_____
<i>PS SCL</i>	Prescaler Scale Value	_____	<i>RR INP 4</i>	Rate A Scaling Point 4 Input	_____
<b>COUNTER B PARAMETERS</b>			<i>RR dSP 5</i>	Rate A Scaling Point 5 Display	_____
<i>Ent b</i>	Counter B Operating Mode	_____	<i>RR INP 5</i>	Rate A Scaling Point 5 Input	_____
<i>dEC Pt</i>	Counter B Decimal Position	_____	<i>RR dSP 6</i>	Rate A Scaling Point 6 Display	_____
<i>SC FAc</i>	Counter B Scale Factor	_____	<i>RR INP 6</i>	Rate A Scaling Point 6 Input	_____
<i>SCALEr</i>	Counter B Scale Multiplier	_____	<i>RR dSP 7</i>	Rate A Scaling Point 7 Display	_____
<i>RESEt</i>	Counter B Reset Action	_____	<i>RR INP 7</i>	Rate A Scaling Point 7 Input	_____
<i>Ent Ld</i>	Counter B Count Load Value	_____	<i>RR dSP 8</i>	Rate A Scaling Point 8 Display	_____
<i>R P-UP</i>	Counter B Reset At Power-Up	_____	<i>RR INP 8</i>	Rate A Scaling Point 8 Input	_____
<b>COUNTER C PARAMETERS</b>			<i>RR dSP 9</i>	Rate A Scaling Point 9 Display	_____
<i>Ent C</i>	Counter C Operating Mode	_____	<i>RR INP 9</i>	Rate A Scaling Point 9 Input	_____
<i>dEC Pt</i>	Counter C Decimal Position	_____	<i>RR dSP 10</i>	Rate A Scaling Point 10 Display	_____
<i>SC FAc</i>	Counter C Scale Factor	_____	<i>RR INP 10</i>	Rate A Scaling Point 10 Input	_____
<i>SCALEr</i>	Counter C Scale Multiplier	_____	<i>ROUAd</i>	Rate A Display Rounding	_____
<i>RESEt</i>	Counter C Reset Action	_____	<i>LO-CUt</i>	Rate A Low Cut-Out	_____
<i>Ent Ld</i>	Counter C Count Load Value	_____	<b>RATE B PARAMETERS</b>		
<i>R P-UP</i>	Counter C Reset At Power-Up	_____	<i>RALE b</i>	Rate B Enable	_____
<b>RATE Rate Parameters</b>			<i>dEC Pt</i>	Rate B Decimal Position	_____
DISPLAY	PARAMETER	USER SETTING	<i>SC PtS</i>	Rate B Scaling Points	_____
<b>RATE A PARAMETERS</b>			<i>Rb dSP 1</i>	Rate B Scaling Point 1 Display	_____
<i>RALE A</i>	Rate A Enable	_____	<i>Rb INP 1</i>	Rate B Scaling Point 1 Input	_____
			<i>Rb dSP 2</i>	Rate B Scaling Point 2 Display	_____
			<i>Rb INP 2</i>	Rate B Scaling Point 2 Input	_____

DISPLAY	PARAMETER	USER SETTING
Rb dSP 3	Rate B Scaling Point 3 Display	_____
Rb INP 3	Rate B Scaling Point 3 Input	_____
Rb dSP 4	Rate B Scaling Point 4 Display	_____
Rb INP 4	Rate B Scaling Point 4 Input	_____
Rb dSP 5	Rate B Scaling Point 5 Display	_____
Rb INP 5	Rate B Scaling Point 5 Input	_____
Rb dSP 6	Rate B Scaling Point 6 Display	_____
Rb INP 6	Rate B Scaling Point 6 Input	_____
Rb dSP 7	Rate B Scaling Point 7 Display	_____
Rb INP 7	Rate B Scaling Point 7 Input	_____
Rb dSP 8	Rate B Scaling Point 8 Display	_____
Rb INP 8	Rate B Scaling Point 8 Input	_____
Rb dSP 9	Rate B Scaling Point 9 Display	_____
Rb INP 9	Rate B Scaling Point 9 Input	_____
Rb dSP 10	Rate B Scaling Point 10 Display	_____
Rb INP 10	Rate B Scaling Point 10 Input	_____
ROUNd	Rate B Display Rounding	_____
LO-CUT	Rate B Low Cut-Out	_____
<b>RATE C PARAMETERS</b>		
RALE C	Rate C Calculation	_____
SCALEr	Rate C Display Multiplier	_____
dEC Pt	Rate C Decimal Position	_____
<b>RATE UPDATE PARAMETERS</b>		
LO-Udt	Rate Low Update Time	_____
HI -Udt	Rate High Update Time	_____
<b>RATE MAX AND MIN CAPTURE</b>		
H, ASN	Max Capture Value Assignment	_____
H, ERP	Max Capture Delay Time	_____
Lo ASN	Min Capture Value Assignment	_____
Lo ERP	Min Capture Delay Time	_____

**USER User Input Parameters**

DISPLAY	PARAMETER	USER SETTING
USRACt	User Input Active State	_____
USER-1	User Input 1	_____
USER-2	User Input 2	_____
USER-3	User Input 3	_____
F 1	Function Key 1	_____
F2	Function Key 2	_____
SEC-F 1	2nd Function Key 1	_____
SEC-F2	2nd Function Key 2	_____

**OUTPUT OUTPUT PARAMETERS**

**SETPnt Setpoint Output Parameters**

DISPLAY	PARAMETER	USER SETTING
SELEct	Setpoint Selection	S1 _____
ASSI GN	Setpoint Source	_____
ACT: ON	Action For Setpoint	_____
LOGI C	Output Logic	_____
Annun	Output Annunciator Light	_____
Co lor	Change Color	_____
SETPnt	Setpoint Value	_____
trAC	Setpoint Tracking	_____
P-UP	Setpoint Output Power-Up State	_____
TYPE	Setpoint Activation Type	_____
StBY	Standby Operation	_____
HYSI	Hysteresis For Setpoint	_____
t-ON	On Time Delay Setpoint	_____
t-OFF	Off Time Delay Setpoint	_____
t-OUT	Setpoint Output Time-Out	_____
1-SHOT	Rate Timed Output One-Shot	_____
Auto	Counter Auto Reset	_____
RESEt	Output Reset W/ Counter Reset	_____
PSI-Sn	Setpoint Output Reset At Sn+1	_____

**ANALOG Analog Output Parameters**

DISPLAY	PARAMETER	USER SETTING
TYPE	Analog Output Type	_____
ASSI GN	Analog Output Assignment	_____
LO-SEL	Analog Low Scale Value	_____
HI -SEL	Analog High Scale Value	_____

**Port COMMS. PORT PARAMETERS**

**USB USB Port Parameters**

DISPLAY	PARAMETER	USER SETTING
CONF 6	USB Configuration	_____

**Serial Serial Port Parameters**

DISPLAY	PARAMETER	USER SETTING
TYPE	Communications Type	_____
BAUD	Baud Rate	_____
DATA	Data Bits	_____
PARI TY	Parity Bit	_____
Addr	Meter Unit Address	_____
dELAY	Transmit Delay	_____
AbbrU	Abbreviated Printing	_____
OPT	Print Options	_____
Cnt A	Counter A	_____
Cnt b	Counter B	_____
Cnt C	Counter C	_____
RALE A	Rate A	_____
RALE b	Rate B	_____
RALE C	Rate C	_____
H, i	Rate Maximum	_____
Lo	Rate Minimum	_____
SC FAc	Scale Factor A & B	_____
Cnt Ld	Counter Load A & B	_____
SETPnt	Setpoint Values	_____

**di SPLY DISPLAY PARAMETERS**

**LINE 1 Line 1 Parameters**

DISPLAY	PARAMETER	USER SETTING
Co lor	Line 1 Display Color	_____
d-LEU	Display Level	_____
d-Cont	Display Contrast Level	_____
SELEcT	Line 1 Display Value Select	_____
	Ent A _____	RALE b _____
	Ent b _____	RALE c _____
	Ent c _____	Hi _____
	RALE A _____	Lo _____
ScroLL	Line 1 Display Scroll Enable/Time	_____
UNITS	Line 1 Units Mnemonic(s)	_____

**LABEL MNEMONIC**

**LABEL**

List A      List B

Unit 1	Line 1 Units Digit 1 (Left)	_____
Unit 2	Line 1 Units Digit 2 (Center)	_____
Unit 3	Line 1 Units Digit 3 (Right)	_____

**LIST A CUSTOM MNEMONICS**

	Unit 1	Unit 2	Unit 3
Counter A	_____	_____	_____
Counter B	_____	_____	_____
Counter C	_____	_____	_____
Rate A	_____	_____	_____
Rate B	_____	_____	_____
Rate C	_____	_____	_____
Max (HI)	_____	_____	_____
Min (LO)	_____	_____	_____

**LIST B CUSTOM MNEMONICS**

	Unit 1	Unit 2	Unit 3
Counter A	_____	_____	_____
Counter B	_____	_____	_____
Counter C	_____	_____	_____
Rate A	_____	_____	_____
Rate B	_____	_____	_____
Rate C	_____	_____	_____
Max (HI)	_____	_____	_____
Min (LO)	_____	_____	_____

**LINE 2 Line 2 Parameters**

ACCESS	LINE 2 VALUE ACCESS
Ent A	_____ S3 _____
Ent b	_____ S4 _____
Ent c	_____ SC FAE cEtA _____
RALE A	_____ SC FAE cEtB _____
RALE b	_____ SC FAE cEtC _____
RALE c	_____ Ent Ld cEtA _____
Hi	_____ Ent Ld cEtB _____
Lo	_____ Ent Ld cEtC _____
LISe	_____ Co lor _____
S1	_____ d-LEU _____
S2	_____ d-Cont _____

**FUNCTION LINE 2 FUNCTIONS ACCESS**

r-L1	_____	r-Hi	_____
r-cEtA	_____	r-Lo	_____
r-cEtB	_____	r-ML	_____
r-cEtC	_____	Print	_____
r-AbE	_____		

ScroLL	Line 2 Display Scroll Enable/Time	_____
--------	-----------------------------------	-------

**UNITS**

UNITS	Line 2 Units Mnemonic(s)	LABEL MNEMONIC	LABEL
			List A      List B
Unit 1	Line 2 Units Digit 1 (Left)		_____
Unit 2	Line 2 Units Digit 2		_____
Unit 3	Line 2 Units Digit 3		_____
Unit 4	Line 2 Units Digit 4		_____
Unit 5	Line 2 Units Digit 5		_____
Unit 6	Line 2 Units Digit 6		_____
Unit 7	Line 2 Units Digit 7		_____
Unit 8	Line 2 Units Digit 8		_____
Unit 9	Line 2 Units Digit 9 (Right)		_____

**LIST A CUSTOM MNEMONICS**

	1	2	3	4	5	6	7	8	9
Counter A	_____	_____	_____	_____	_____	_____	_____	_____	_____
Counter B	_____	_____	_____	_____	_____	_____	_____	_____	_____
Counter C	_____	_____	_____	_____	_____	_____	_____	_____	_____
Rate A	_____	_____	_____	_____	_____	_____	_____	_____	_____
Rate B	_____	_____	_____	_____	_____	_____	_____	_____	_____
Rate C	_____	_____	_____	_____	_____	_____	_____	_____	_____
Max (HI)	_____	_____	_____	_____	_____	_____	_____	_____	_____
Min (LO)	_____	_____	_____	_____	_____	_____	_____	_____	_____

**LIST B CUSTOM MNEMONICS**

	1	2	3	4	5	6	7	8	9
Counter A	_____	_____	_____	_____	_____	_____	_____	_____	_____
Counter B	_____	_____	_____	_____	_____	_____	_____	_____	_____
Counter C	_____	_____	_____	_____	_____	_____	_____	_____	_____
Rate A	_____	_____	_____	_____	_____	_____	_____	_____	_____
Rate B	_____	_____	_____	_____	_____	_____	_____	_____	_____
Rate C	_____	_____	_____	_____	_____	_____	_____	_____	_____
Max (HI)	_____	_____	_____	_____	_____	_____	_____	_____	_____
Min (LO)	_____	_____	_____	_____	_____	_____	_____	_____	_____

**CODE**

Security Code \_\_\_\_\_



**This page intentionally left blank.**

# PAX2D PROGRAMMING QUICK OVERVIEW

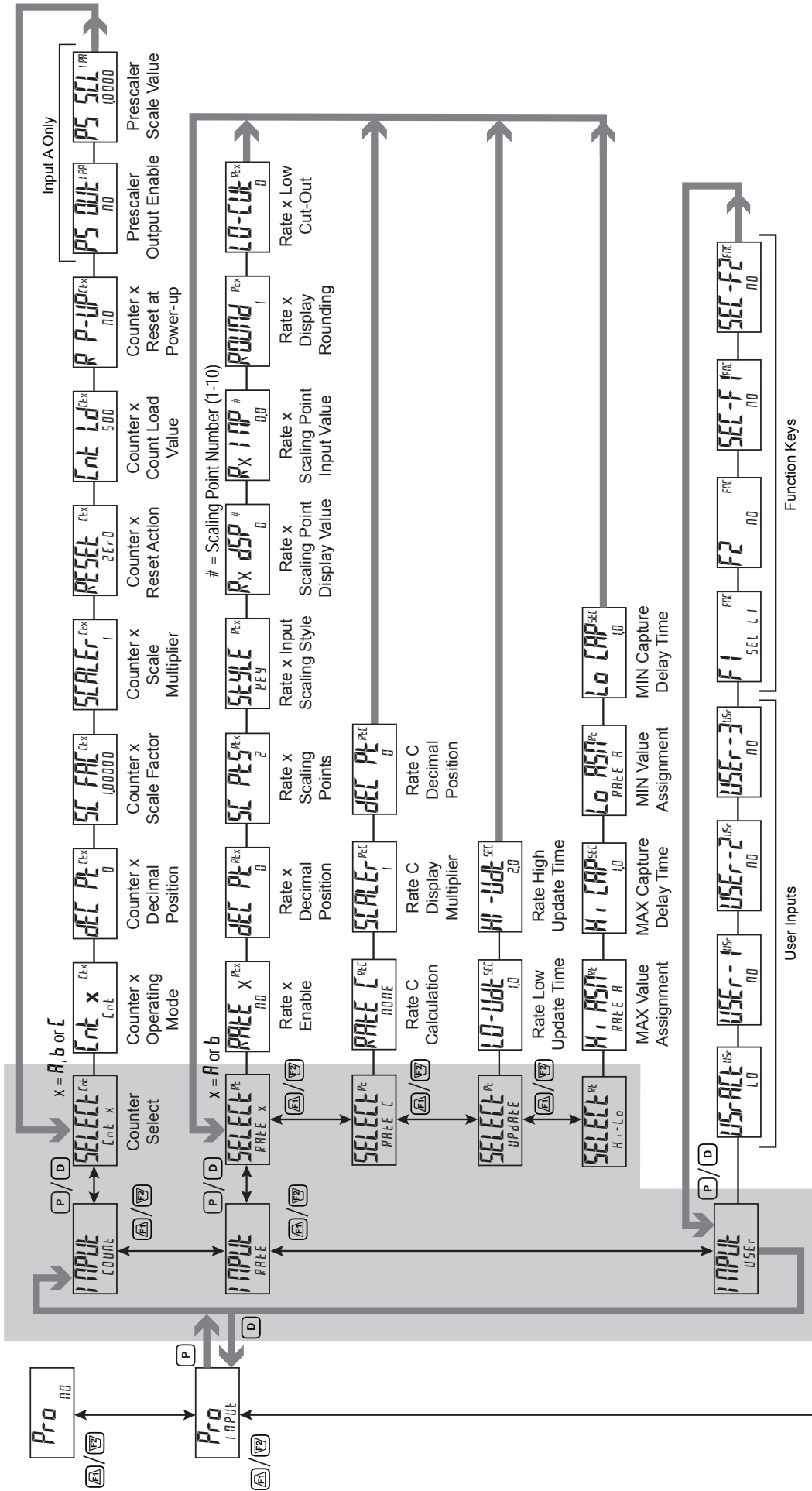



### **LIMITED WARRANTY**

The Company warrants the products it manufactures against defects in materials and workmanship for a period limited to two years from the date of shipment, provided the products have been stored, handled, installed, and used under proper conditions. The Company's liability under this limited warranty shall extend only to the repair or replacement of a defective product, at The Company's option. The Company disclaims all liability for any affirmation, promise or representation with respect to the products.

The customer agrees to hold Red Lion Controls harmless from, defend, and indemnify RLC against damages, claims, and expenses arising out of subsequent sales of RLC products or products containing components manufactured by RLC and based upon personal injuries, deaths, property damage, lost profits, and other matters which Buyer, its employees, or sub-contractors are or may be to any extent liable, including without limitation penalties imposed by the Consumer Product Safety Act (P.L. 92-573) and liability imposed upon any person pursuant to the Magnuson-Moss Warranty Act (P.L. 93-637), as now in effect or as amended hereafter.

No warranties expressed or implied are created with respect to The Company's products except those expressly contained herein. The Customer acknowledges the disclaimers and limitations contained herein and relies on no other warranties or affirmations.

Red Lion Controls  
Headquarters  
20 Willow Springs Circle  
York PA 17406  
Tel +1 (717) 767-6511  
Fax +1 (717) 764-0839

Red Lion Controls  
Europe  
Printerweg 10  
NL - 3821 AD Amersfoort  
Tel +31 (0) 334 723 225  
Fax +31 (0) 334 893 793

Red Lion Controls  
India  
54, Vishvas Tenement  
GST Road, New Ranip,  
Ahmedabad-382480 Gujarat, India  
Tel +91 987 954 0503  
Fax +91 79 275 31 350

Red Lion Controls  
China  
Unit 101, XinAn Plaza  
Building 13, No.99 Tianzhou Road  
ShangHai, P.R. China 200223  
Tel +86 21 6113-3688  
Fax +86 21 6113-3683