

# CRIMSON 3.0

## TUTORIALS



**red lion**<sup>®</sup>



---

## TABLE OF CONTENTS

Applicable Products .....	3
Multiple Communication Ports.....	5
Protocol Conversion .....	7
Data Logging .....	9
Web Server .....	11
Ethernet Connectivity .....	13
OPC Server .....	15
Symbol Library .....	17
Languages and Unicode Characters.....	19
Animation .....	21
Email/SMS Notification .....	23
FTP Synchronization .....	25
FTP Server .....	27
Free Online Update.....	31
Pass Through Programming.....	33
Modem Connectivity .....	35
Security Manager .....	37
Non Volatile Memory.....	39
USB Connection .....	41
Math and Formulas .....	43
Recipes and Arrays .....	45
Built In Compiler .....	47
Event Logging.....	51
Security Logging.....	53
CompactFlash Card Access .....	55
Emulator.....	59
USB Memory Stick Support .....	61
Online Tag Viewing.....	65
Platform Conversion .....	67

---



## APPLICABLE PRODUCTS

Crimson 3.0 is the common programming platform for a variety of Red Lion products, including the G3 and G3 Kadet series HMIs, Data Station Plus, Modular Controller and the ProductVity Station™. While the majority of this tutorial applies to each of these products, not all features are available on every model. Please refer to the data sheet of the specific model for more information.





# MULTIPLE COMMUNICATION PORTS

## DESCRIPTION

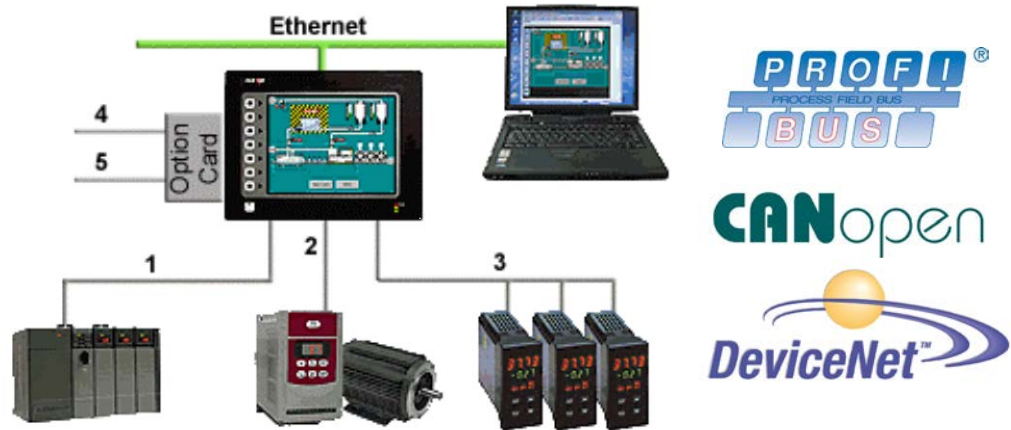

With three serial ports standard, (up to five with optional expansion card), and an Ethernet port capable of running four protocols, the G3 is the most powerful communications platform available today. Pick the best-in-class PLC, drive, temperature controllers, etc. for your next machine. The Red Lion G3 will make sure they communicate seamlessly to one another.

## BENEFITS

- Save time by avoiding communication card setup and programming in PLCs and other devices.
- Embedded drivers for all major automation manufacturers (180+).
- No extra hardware required when adding new equipment.

## EXAMPLE

A machine manufacturer provides extra functionalities for his customer by displaying all of the process data from the multiple devices necessary for his plastic injection units.



# CONFIGURING MULTIPLE PROTOCOLS IN JUST 5 STEPS

**Step 1** Enter the "Communications" module.



**Step 2** Select a serial port and choose the manufacturer.

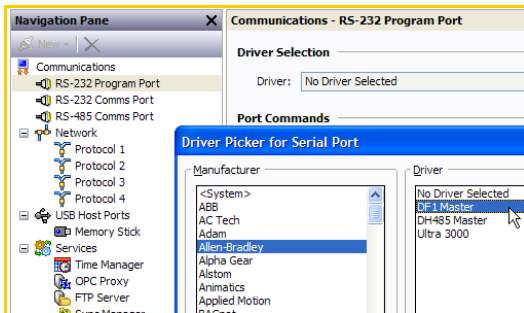

**Step 3** Select the driver.

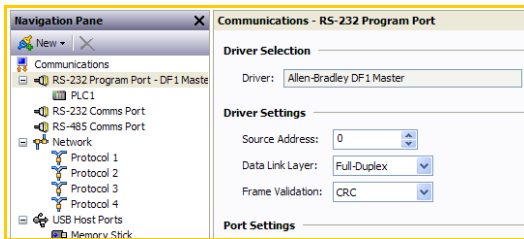

**Step 4** Enable the Ethernet port.

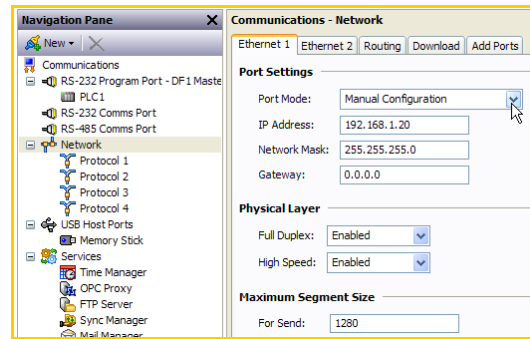

**Step 5** Select an Ethernet protocol.

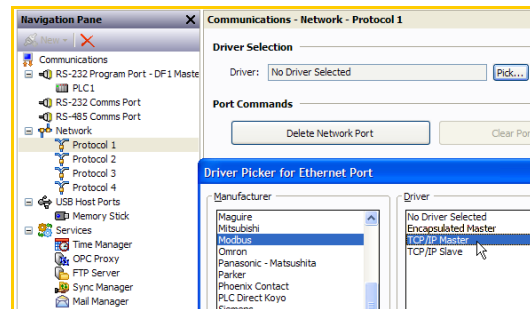

Communication setup complete!

For more information on Crimson 3.0, refer to the manual.



# PROTOCOL CONVERSION

## DESCRIPTION



With the G3's powerful protocol converter, you have the ability to exchange data between any and all connected devices. With a few clicks of the mouse, you can map a setpoint from a PLC to a variable speed drive, or provide a PLC program with information as to the status of a PID controller.

## BENEFITS

- Save time by avoiding communication card setup and programming in PLCs and other devices.
- Exchange data between connected devices seamlessly.
- No extra hardware required when adding new equipment.

## EXAMPLE

An OEM provides options for end users on his weighing system. By connecting optional devices to available communication ports on the G3, exchanging data with the controller is done in minutes with no extra programming or hardware necessary.

# PROTOCOL CONVERSION IN JUST 5 STEPS

**Step 1** Select your first protocol.

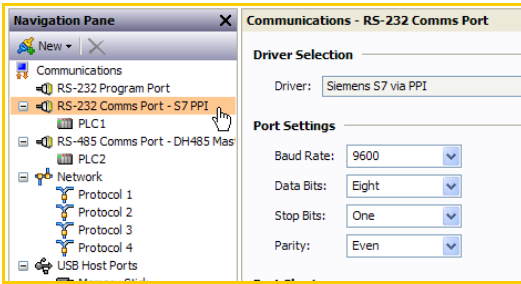

**Step 4** Drag and drop your other device's data.

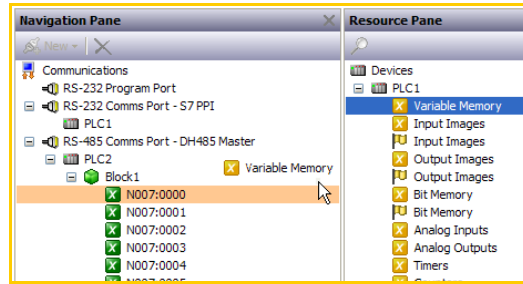

**Step 2** Select your second protocol.

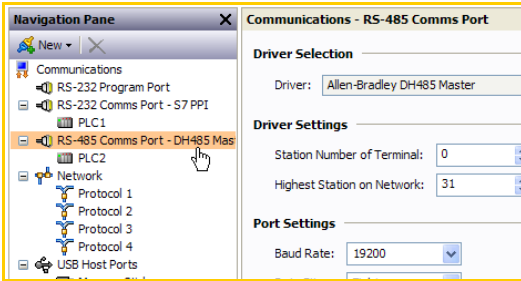

**Step 5** Finished!

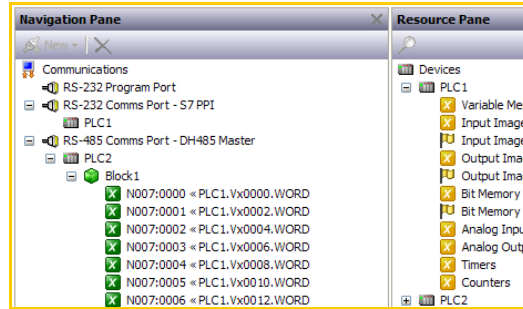

**Step 3** Create a gateway block to exchange data.

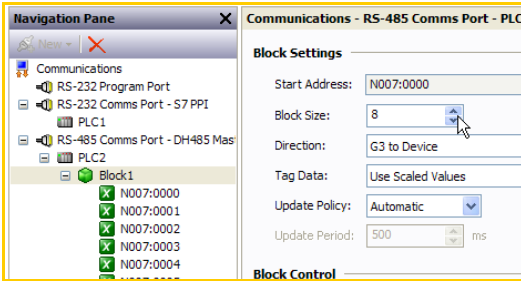

For more information on Crimson 3.0, refer to the manual.

# DATA LOGGING

## DESCRIPTION

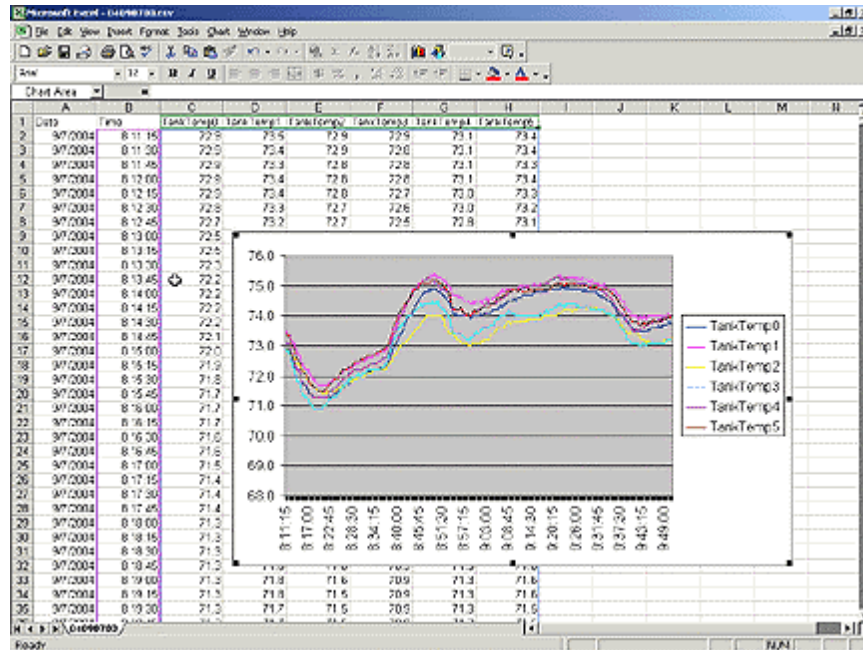

The G3 will log tags at user-programmable rates, and automatically time/date stamp them. This information is stored in open CSV file format, allowing you to access the data with virtually any application, including Microsoft Office applications.

## BENEFITS

- Record your system’s performance for faultfinding or process improvement.
- Facilitate preventive maintenance by monitoring critical areas of your system.
- Built in data logger provides “IT-Ready” data in CSV file format.

## EXAMPLE

A cold storage facility uses the G3 to monitor and record multiple refrigerators data to ensure that the food is kept at safe temperatures. If a problem occurs, the G3 notifies the appropriate personnel before unsafe conditions are reached. Further, by monitoring the refrigeration system’s response to events, such as a door causing a temperature rise, the health of the system can be evaluated.



## DATA LOGGING IN 6 STEPS

**Step 1** Enter the "Data Logger" module.



**Step 2** Create a data log.

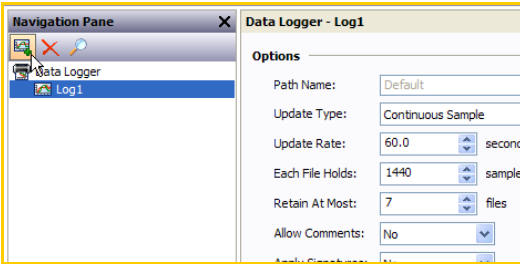

**Step 3** Define the data logging sample rate.

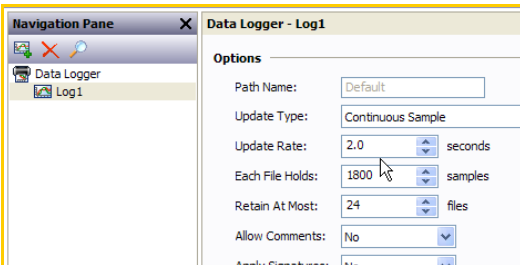

**Step 4** Define the number of samples per file.

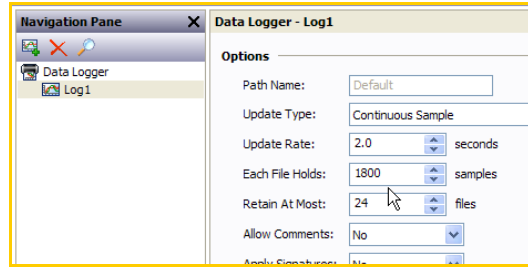

**Step 5** Define the maximum number of files. The G3 automatically erases older files as new files are added.

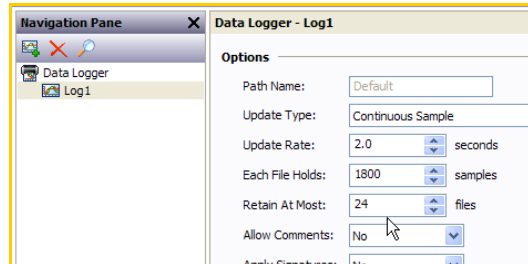

**Step 6** Add tags to the log by double-clicking them, or by dragging them from the resource pane.

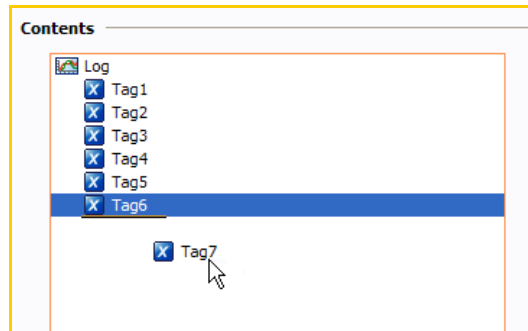

In this example, the G3 will log the last 24 hours of data, with each file representing one hour of samples.

Data Logging complete!

For more information on Crimson 3.0, refer to the manual.

## WEB SERVER

### DESCRIPTION



Through use of the G3's built-in web server, any page within the database is immediately accessible via web browser. This allows remote personnel to view, as well as control, the HMI from anywhere in the world. For added flexibility, the G3 can also be configured to serve custom HTML pages created in any HTML editor.

### BENEFITS

- Remotely access your application from anywhere.
- Access your system information and status, download process data and log files.

### EXAMPLE

A carwash owner uses the G3 to connect to his various installations via a web browser. This allows him to check the condition of each bay's equipment, as well as the financial performance of each location. If intervention is required, e.g. shutdown due to a water leak, the customer can take action without leaving his home.



## ACTIVATING THE WEB SERVER

**Step 1** Enter the "Communications" module.



**Step 2** Enable the Ethernet port.

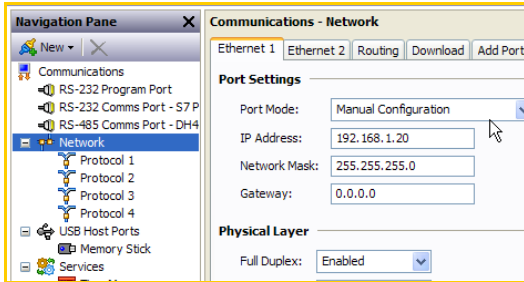

**Step 3** Enter the "Web Server" module.

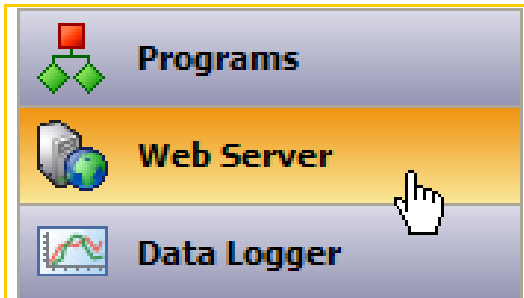

**Step 4** Enable the server.

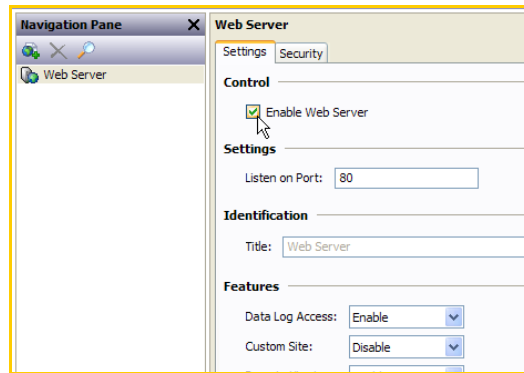

**Step 5** Enable the desired level of remote control.

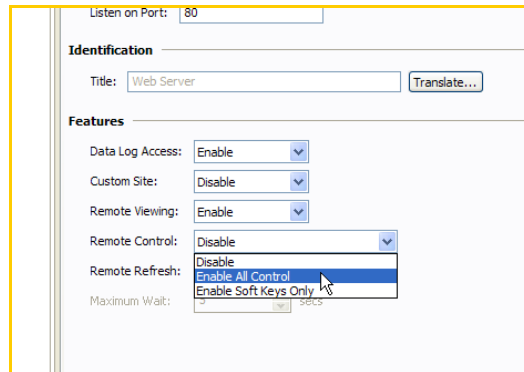

Web Server set up complete!

For more information on Crimson 3.0, refer to the manual.

# ETHERNET CONNECTIVITY

## DESCRIPTION

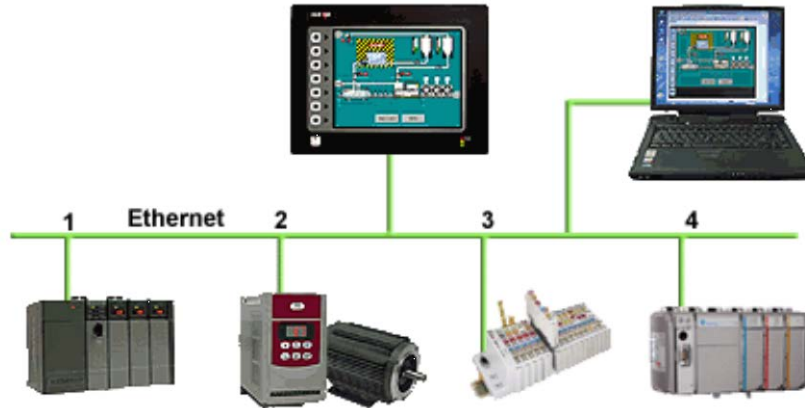

With an Ethernet port capable of running four protocols, in addition to all of the serial ports, the G3 is the most powerful communications platform available today. Pick the best-in-class PLC, drive, temperature controllers, etc. for your next machine. The Red Lion G3 will make sure they communicate seamlessly to one another.

## BENEFITS

- Connect any Ethernet enabled equipment to the HMI and access the device's data.
- Up to 4 different protocols provide extensive communication on Ethernet with more than 30 built in drivers for easy programming.
- Gateway functionalities to transfer data from any HMI serial port to Ethernet and vice versa.

## EXAMPLE

A customer wanted to connect his existing Ethernet based PLC to a drive, which was also equipped with Ethernet. By using the protocol capability of the G3 series HMI, the customer integrated the two easily.

By upgrading existing machines with the G3 series HMI, the customer immediately added Ethernet connectivity to them – something that was previously considered too costly. Now these machines are capable of providing production data, without the risk associated with attempting to upgrade the PLC.

# ETHERNET COMMUNICATION IN JUST 4 STEPS

**Step 1** Enter the "Communications" module.



**Step 2** Select the Ethernet port and enter the G3's IP address.

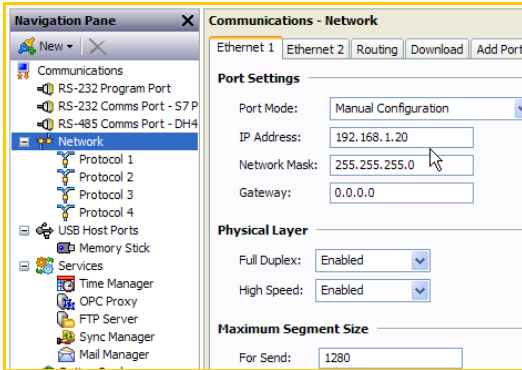

**Step 3** Select the manufacturer and pick a driver.

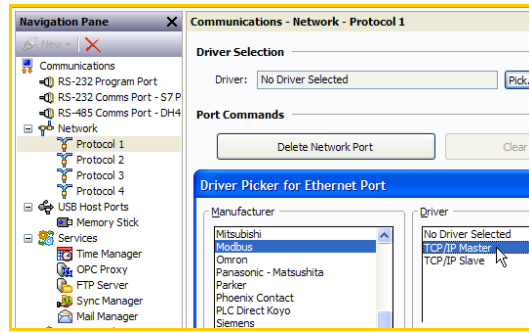

**Step 4** Enter the target device's IP address.

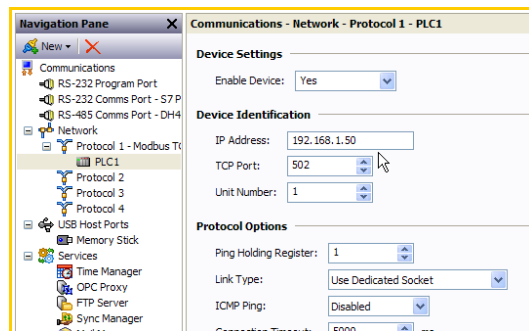

Ethernet communication setup complete!

For more information on Crimson 3.0, refer to the manual.



## OPC SERVER

### DESCRIPTION

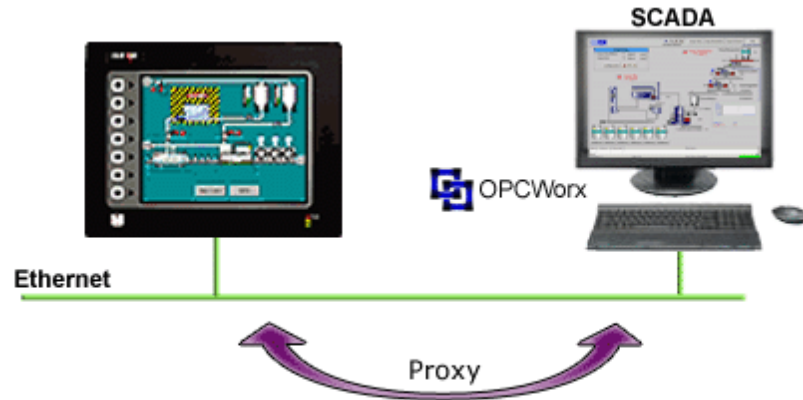

Red Lion's OPCWorx is a configuration tool for our OPC servers. This easy-to-use software allows you to create and configure an OPC server to communicate with the G3 series HMI, the Data Station Plus or the Enhanced Master, as well as devices that support Modbus. Any SCADA package that provides OPC connectivity can then access the G3's tags via their given name.

### BENEFITS

- Connect a SCADA package and access the G3 tags in just few steps.

### EXAMPLE

A production manager decides to centralize data from multiple extrusion lines. Each line is composed of multiple controllers and a G3 HMI. By simply connecting the G3s to the corporate Ethernet network and installing OPCWorx software on the SCADA PC, the manager can now access any process data coming from the manufacturing floor.

# CONFIGURING A G3 TO SCADA CONNECTION IN JUST 8 STEPS

**Step 1** Enter the "Communications" module.



**Step 2** Select the Ethernet port and enter the G3's IP address.

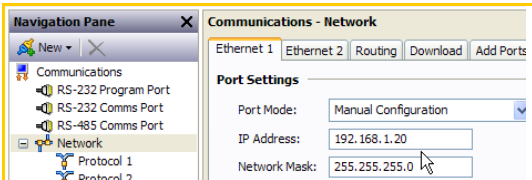

**Step 3** Enable the OPC proxy connection.

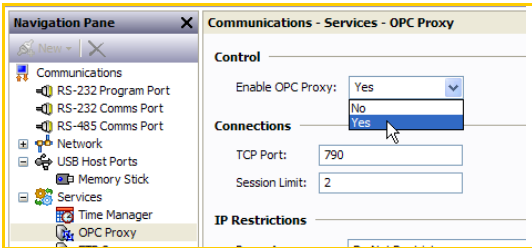

**Step 4** Run OPCWorx software on the PC with the SCADA package.

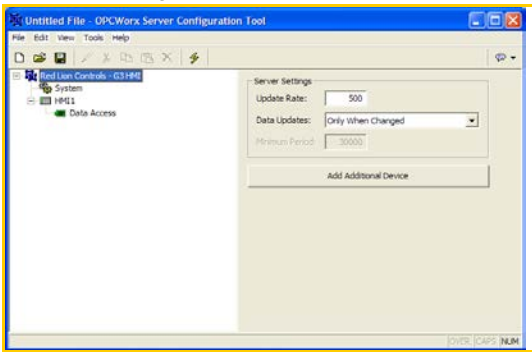

**Step 5** Reference the G3's database.

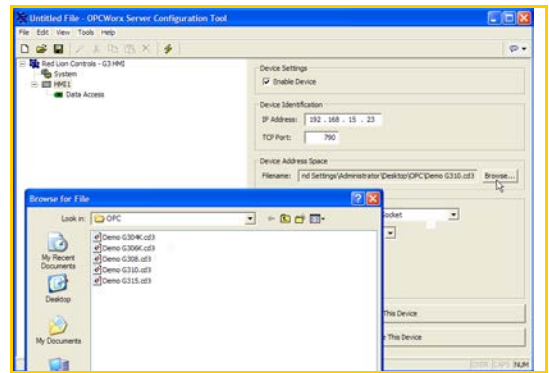

**Step 6** Enter the G3's IP address.

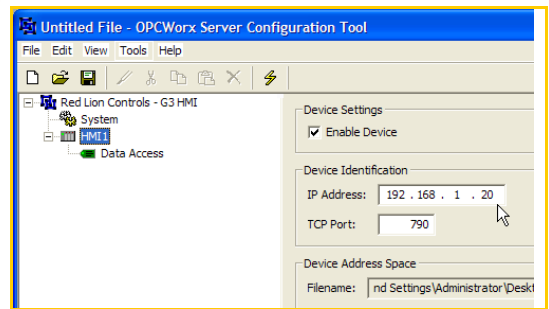

**Step 7** Click auto configure to get the tag list from the G3 database.

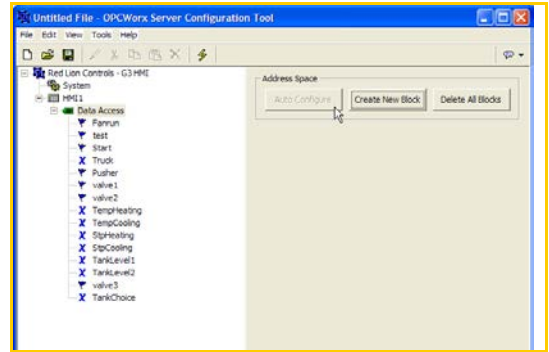

**Step 8** Activate the server.

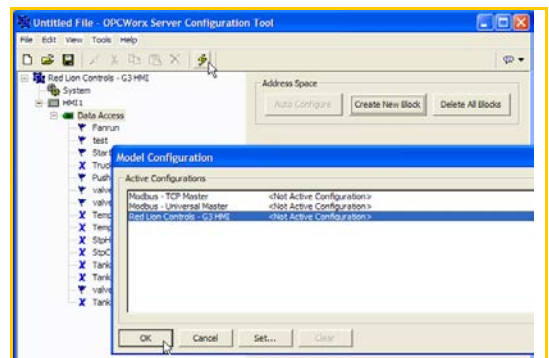

For more information on Crimson 3.0, refer to the manual.

# SYMBOL LIBRARY

## DESCRIPTION



The free Crimson 3.0 configuration software contains over 4000 industrial graphics in over 60 different categories. Now you can create a professional looking HMI user interface with very little effort.

## BENEFITS

- Provides realistic graphics for your application.
- Saves database development time.

## ADD PROFESSIONAL GRAPHICS IN JUST 5 STEPS

**Step 1** Enter the "Display Pages" category.

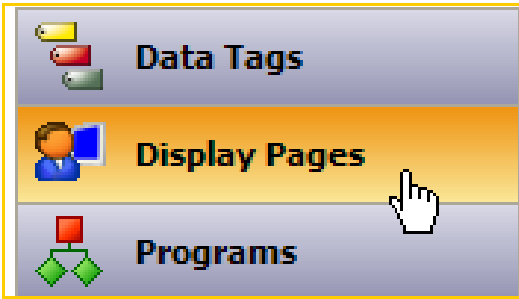

**Step 2** Click on Symbols in the resource pane, and pick a category.

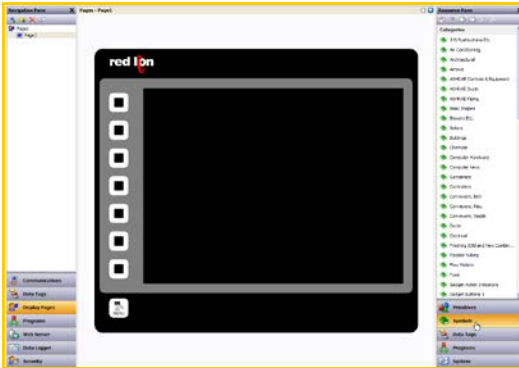

**Step 3** Click a symbol, and hold the mouse key.

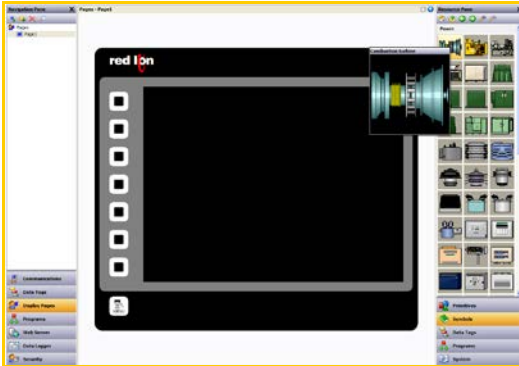

**Step 4** Drag the symbol onto the page.

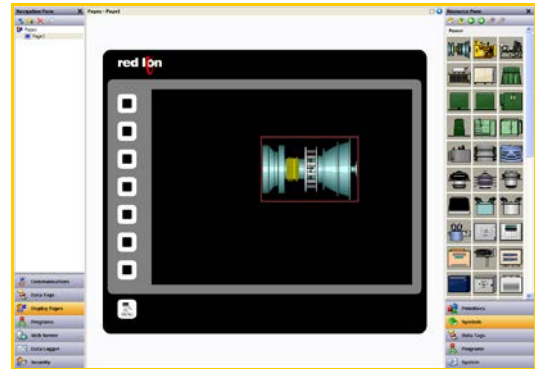

**Step 5** Use the handles to size the object as desired.

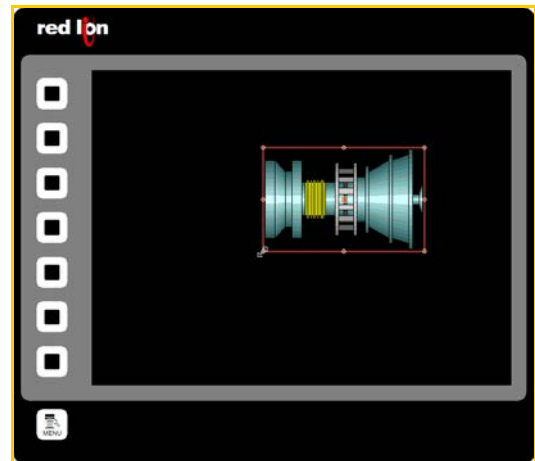

For more information on Crimson 3.0, refer to the manual.

# LANGUAGES AND UNICODE CHARACTERS

## DESCRIPTION

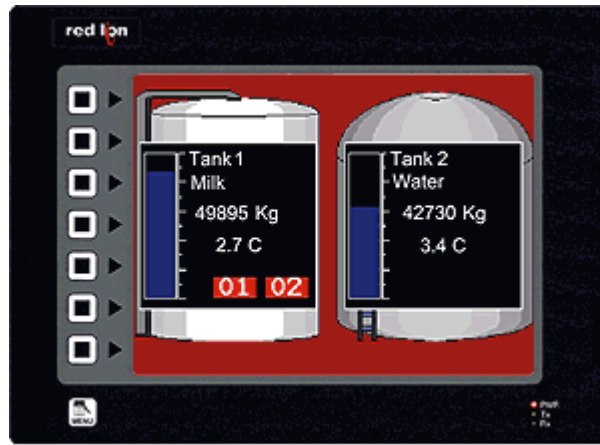

Crimson offers support for thousands of characters used in formats like Cyrillic or Thai. With a single button press, you can adjust the panel's operator language. This allows OEMs to use a single database when targeting multiple geographic markets.

## BENEFITS

- Export your system internationally in the local language.
- Enhance the graphical aspect by using any fonts available in Windows.

## EXAMPLE

An OEM machine manufacturer simplified his support efforts by creating a single database for the G3 HMI. Now when a customer receives their machine, they simply select the language that they need.

# SET UP MULTIPLE LANGUAGES IN JUST 5 STEPS

**Step 1** Enter the "User Interface" module.

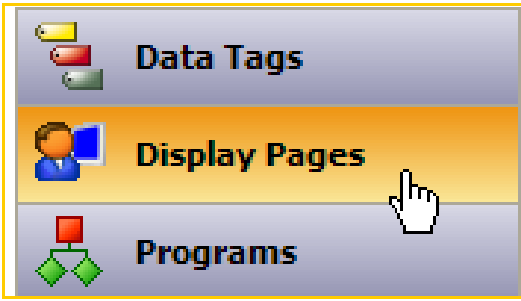

**Step 2** On "Pages", click "Select languages".

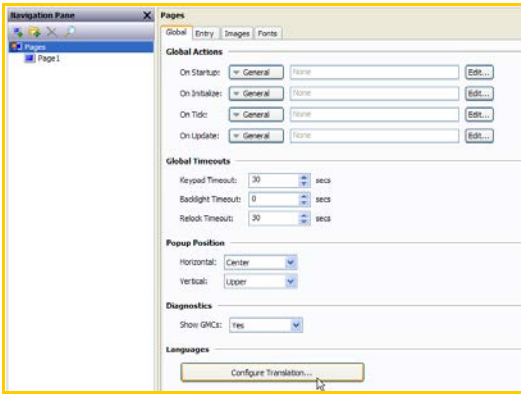

**Step 3** Define the languages you want.

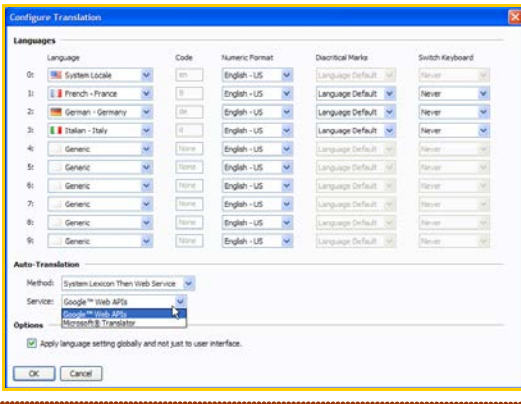

**Step 4** During programming, just click the translate buttons to enter the correct text, or click the Auto-Translate function to use a web-based service.

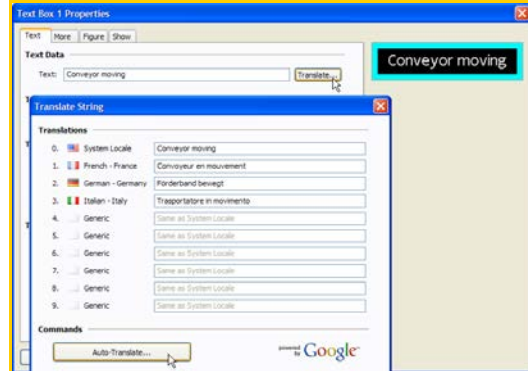

**Step 5** Languages can be selected using the SelectLanguage(int) function called with flag buttons.



Pressing the flags will switch languages!

For more information on Crimson 3.0, refer to the manual.

# ANIMATION

## DESCRIPTION



Create realistic depictions of the equipment through the use of animation. Any object within Crimson's Symbol Library, as well as imported JPEGs, bitmaps and WMF files can be animated.

## BENEFITS

- OEMs can differentiate themselves from their competition with an intuitive user interface.
- Operators can more easily comprehend the system's status through use of animation.

## CREATING ANIMATION IN JUST 6 STEPS

**Step 1** Enter the "User Interface" module.

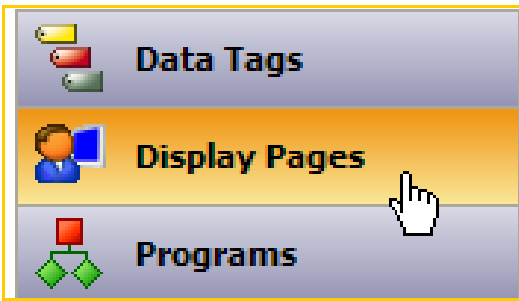

**Step 2** Insert a symbol from the library.

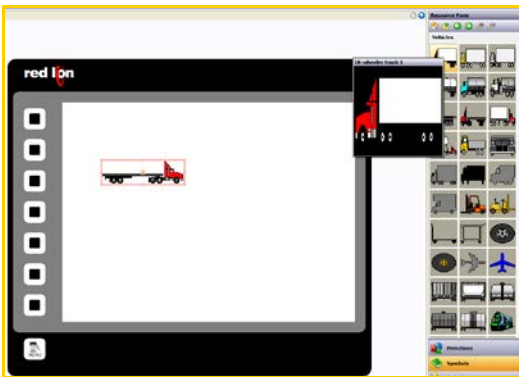

**Step 3** Select the symbol, and use the Behavior menu to add 2D movement.

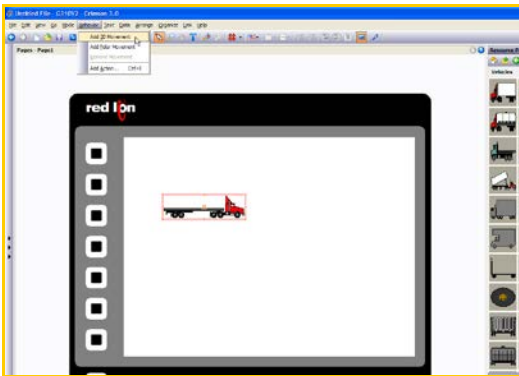

**Step 4** Using the handles of the red rectangle, adjust the range of movement.

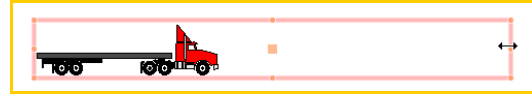

**Step 5** Open the properties of the animation rectangle. Enter the tag name that will control the object's position.

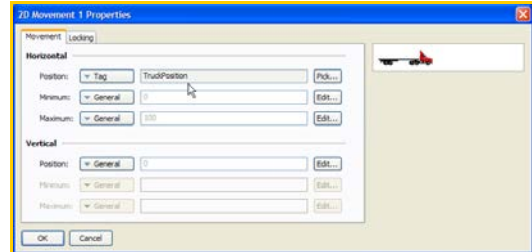

**Step 6** When the tag value changes, the object moves.

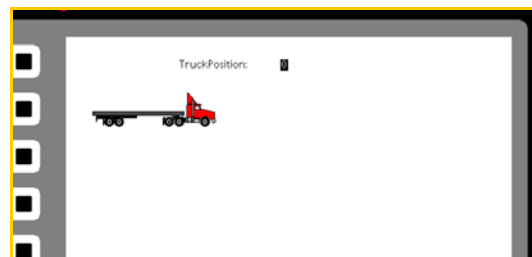

Object animation complete!

For more information on Crimson 3.0, refer to the manual.



# EMAIL/SMS NOTIFICATION

## DESCRIPTION

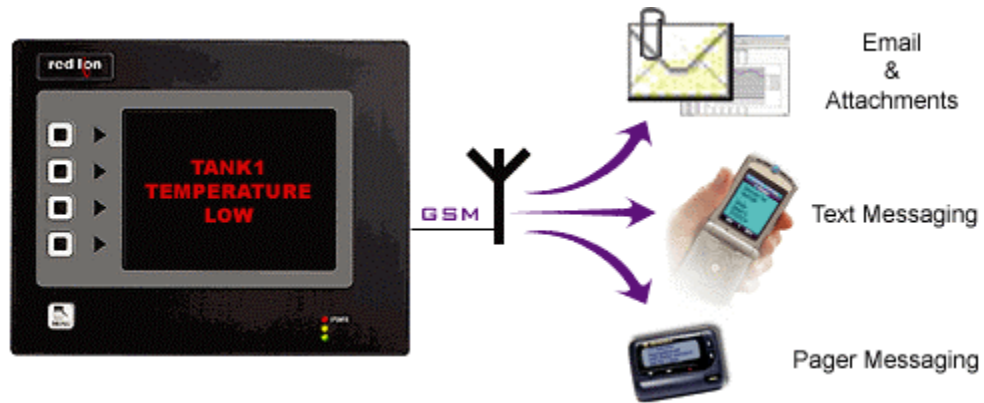

You can choose to email alarm messages, or use the G3's SMS messaging function to text message one or several people simultaneously. With the built-in SMS relay facility, any response given to the original text message is relayed automatically to everyone on the distribution list. This allows a team of responders to know who has taken ownership of a given situation.

## BENEFITS

- Notify the appropriate personnel of impending problems before they occur.
- Allows remote sites to send information on their status and operation.

## EXAMPLE

A remote water treatment plant sends an email every evening with the current temperature and flow status providing ready to use data for preventive maintenance.

In case of problems, text messages will be sent to the maintenance personnel with a description of the issue for rapid and efficient intervention.



# TEXT MESSAGING IN 7 STEPS

**Step 1** Enter the "Communications" module.



**Step 2** Select a serial port and choose the SMS via GSM Modem driver.

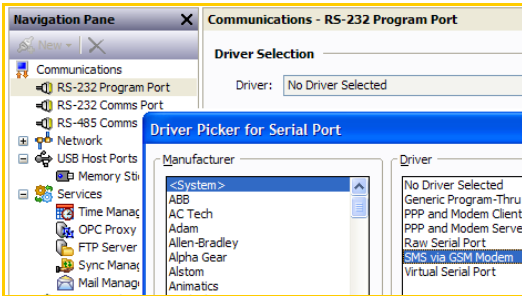

**Step 3** Enable the Mail Manager, then click Contacts.

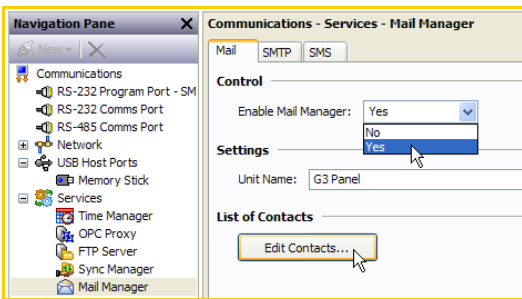

**Step 4** Create a contact and insert a phone number(s).

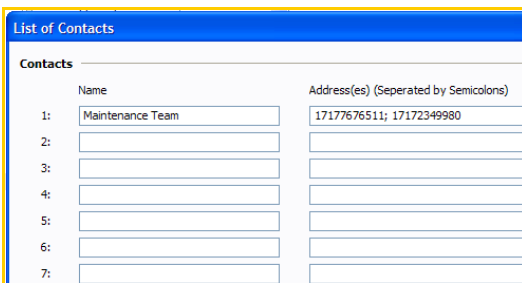

**Step 5** Enable SMS Transport Mode.

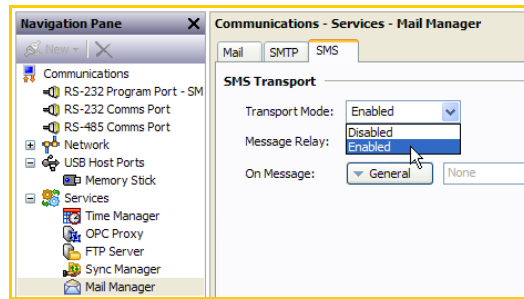

**Step 6** Create an alarm on a tag.

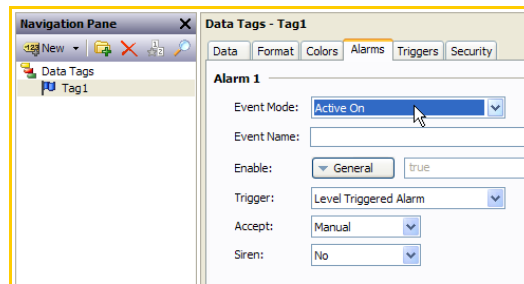

**Step 7** Define the contact targeted by the alarm.

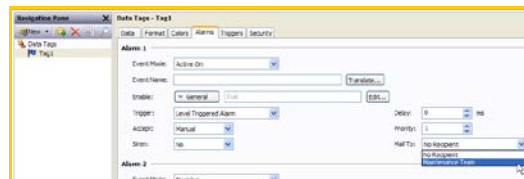

When the alarm is true, a text message will be sent to the appropriate contact. The message content is the alarm text.

Text messaging complete!

For more information on Crimson 3.0, refer to the manual.

# FTP SYNCHRONIZATION

## DESCRIPTION

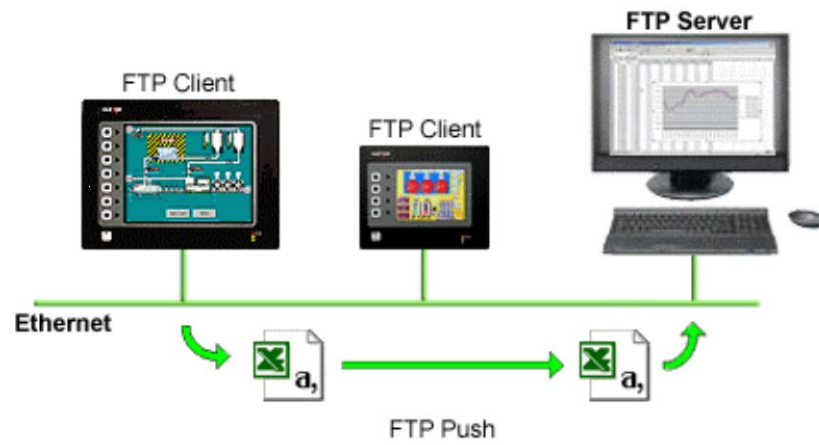

Synchronize log and event files from the HMI to a PC for permanent storage and further analysis. The G3's FTP synchronization can be performed automatically or on demand.

## BENEFITS

- Access your process data or production reports directly on your PC or local server.
- Simple to use and fully automatic – no actions are necessary to retrieve your data.

## EXAMPLE

On a factory floor, multiple metal press lines produce cutouts. Each press is supervised via a G3 HMI. Every shift, each G3 synchronizes with the server to upload the latest data logs for the production manager's review. The G3 also synchronizes with the maintenance PC to upload a report on the machine status. A local program loads an incoming report and analyzes the data to inform if any preventive maintenance action should be started.

## FTP SYNCHRONIZATION IN 6 STEPS

**Step 1** Enter the "Communications" module.



**Step 2** Enable Synchronization manager and Log File Sync.

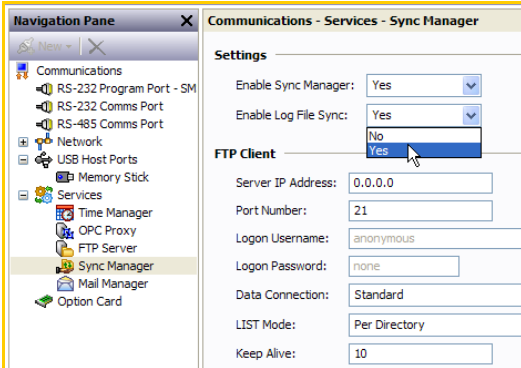

**Step 3** Enter the FTP server's IP address.

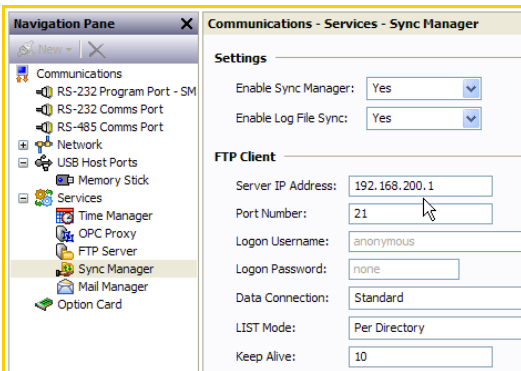

**Step 4** Enter the User name and Password for the G3 to log onto the server.

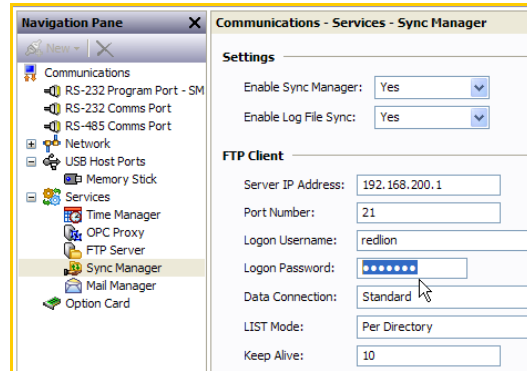

**Step 5** Define the PC root directory where the files will be saved.

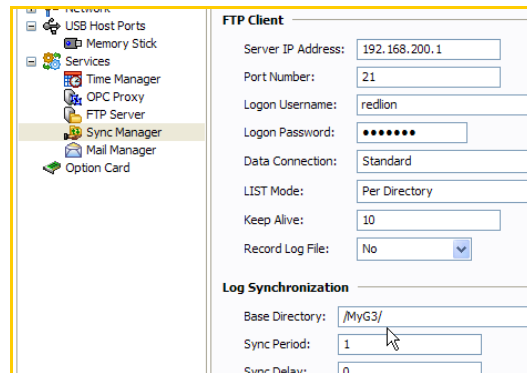

**Step 6** Enter the synchronization frequency.

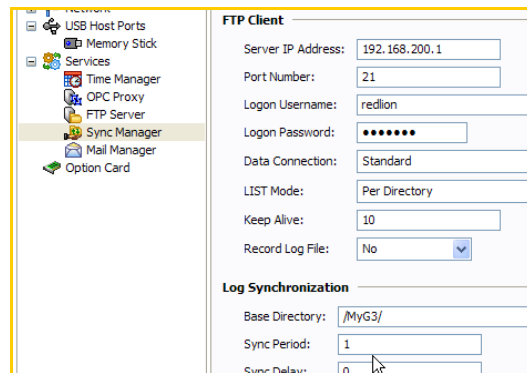

The G3 will synchronize the content of the CompactFlash card with the FTP server as defined in the Sync period.

For more information on Crimson 3.0, refer to the manual.

# FTP SERVER

## DESCRIPTION

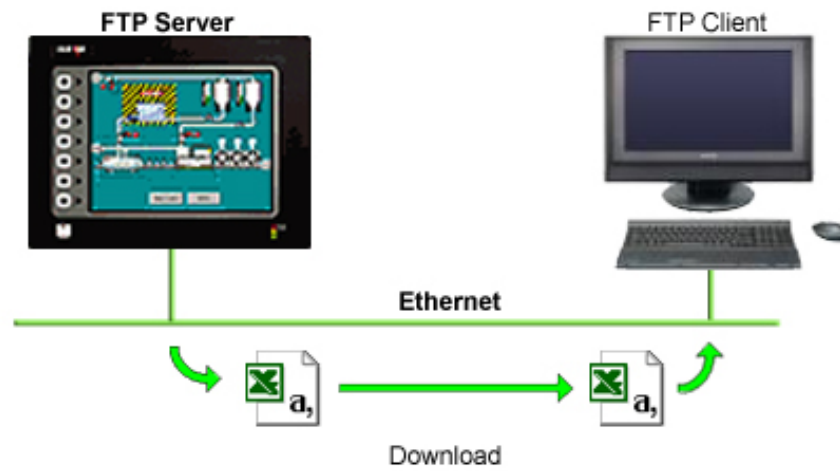

Connect to the HMI via FTP to download or upload any files available on the CompactFlash Card. Easily update recipe files or access log information from your web browser, Windows Explorer or any FTP client software.

## BENEFITS

- Provides an easy way to access, download and upload files on the G3 CompactFlash card.
- Update your custom web site remotely by uploading new HTML pages.
- Load new recipe files or access latest error logs for maintenance.

# ACCESSING THE FTP SERVER IN 10 STEPS

**Step 1** Enter the "Communication" module.



**Step 2** Select the Ethernet port and enter the G3's IP address.

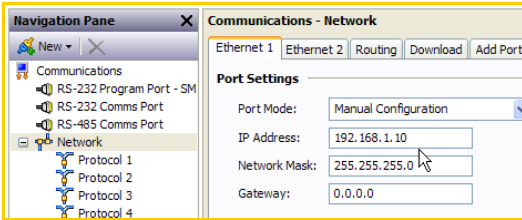

**Step 3** Enable the FTP server.

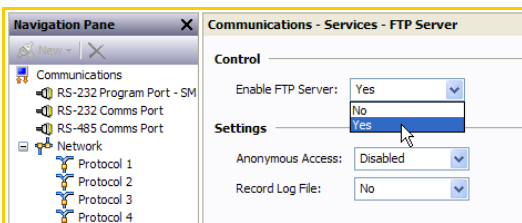

**Step 4** Enter the Security category.



**Step 5** Create a new user.

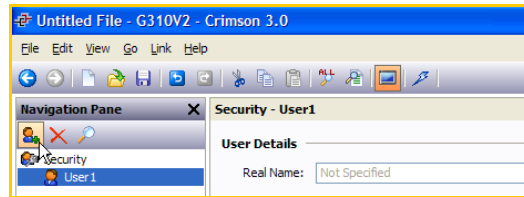

**Step 6** Assign a username and password.

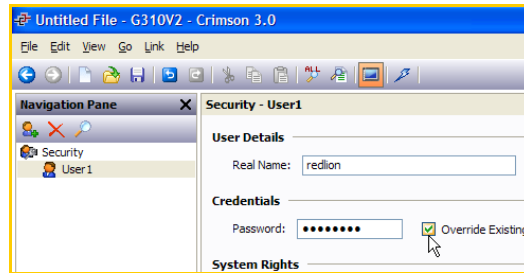

**Step 7** Check FTP user rights.

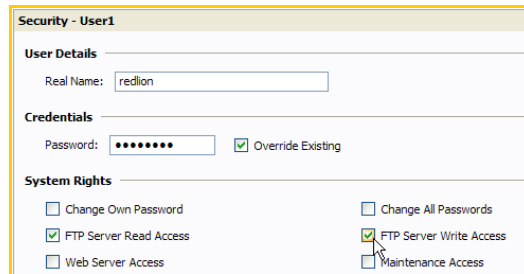

**Step 8** Launch a web browser and enter ftp://192.168.1.10 .



**Step 9** Enter login information.

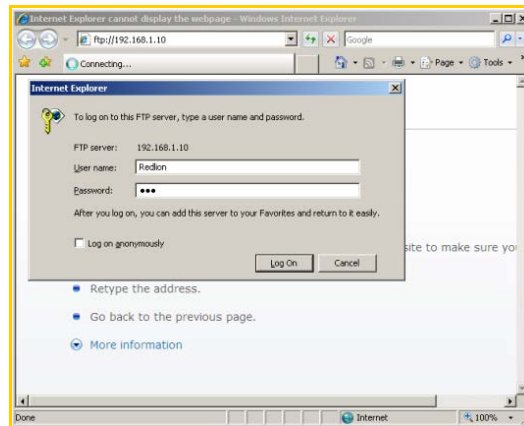

Step 10 on following page.

**Step 10** The browser displays available data.

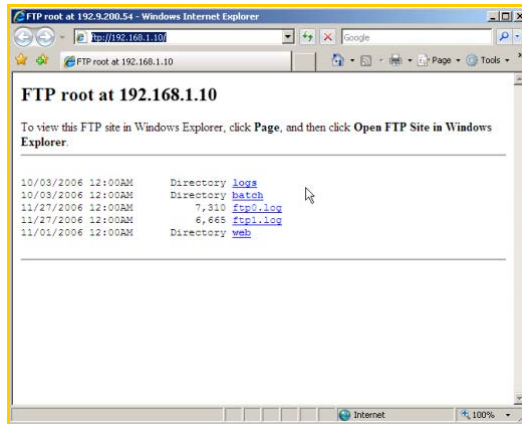

The browser will now display a page to access all information available on the HMI CompactFlash card.

For more information on Crimson 3.0, refer to the manual.





# FREE ONLINE UPDATE

## DESCRIPTION

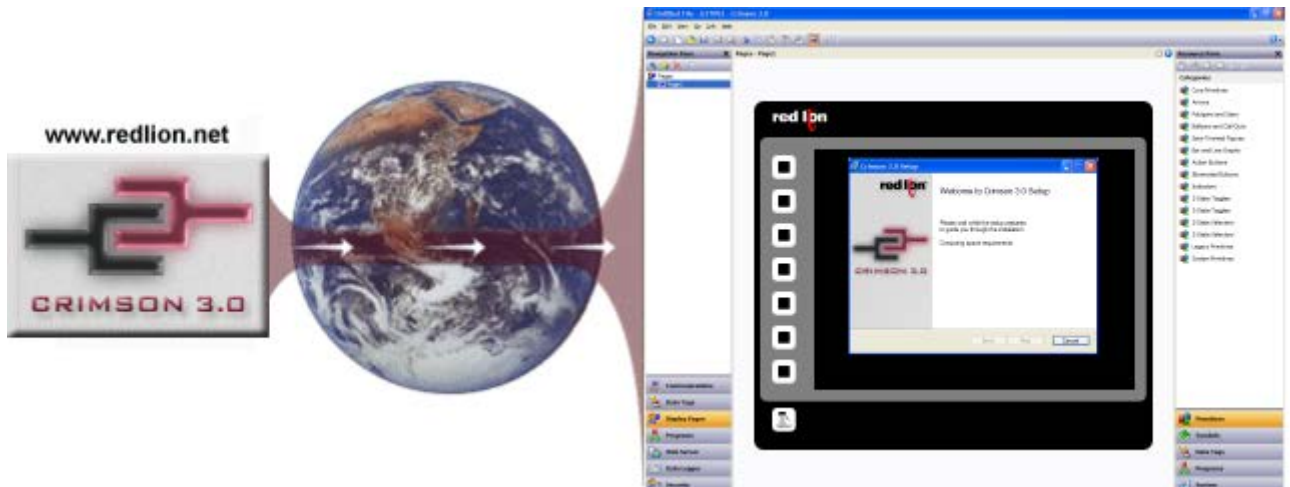

Free online updates allow you to keep your copy of Crimson 3.0 current with the most up-to-date features. New updates include enhanced functionalities, product support, drivers and firmware.

## BENEFITS

- No cost to stay up-to-date with the software.
- Your G3 always stays up-to-date as firmware is upgraded.
- Get the latest features and G3 enhancements for free.

## EXAMPLE

Using Crimson 3.0, an OEM user can get the latest features to upgrade his system to an even more powerful solution for his customers, staying ahead of his competition by providing new tools.

## FREE ONLINE UPDATE IN 2 STEPS

**Step 1** In Crimson 3.0, click “Help”, then “Check for update”.

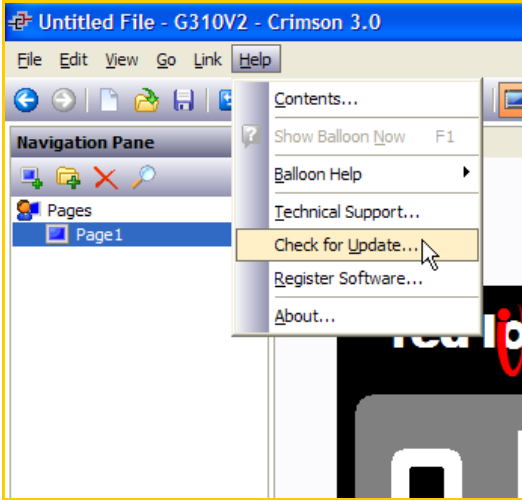

Your PC needs to be connected to the Internet. If a new software version is available, it will then download and install.

**Step 2** By registering, you will be notified of new software releases and features.

A screenshot of the "Register Your Copy of Crimson 3" dialog box. It contains the following fields and options:

- Details:**
  - Name: John Doe
  - Email: JohnD@internet.com
  - Company: Home Office
  - Street: (empty)
  - City: (empty)
  - State: (empty)
  - ZIP: (empty)
  - Country: UNITED STATES (dropdown menu)
  - Product ID: 76487-OEM-0011903-00101
- Send me data on Crimson 3 updates.
- Send me data on Red Lion products.
- Status:** Opening internet connection.
- Buttons: Register, Skip

Free online update complete!

For more information on Crimson 3.0, refer to the manual.

# PASS THROUGH PROGRAMMING

## DESCRIPTION

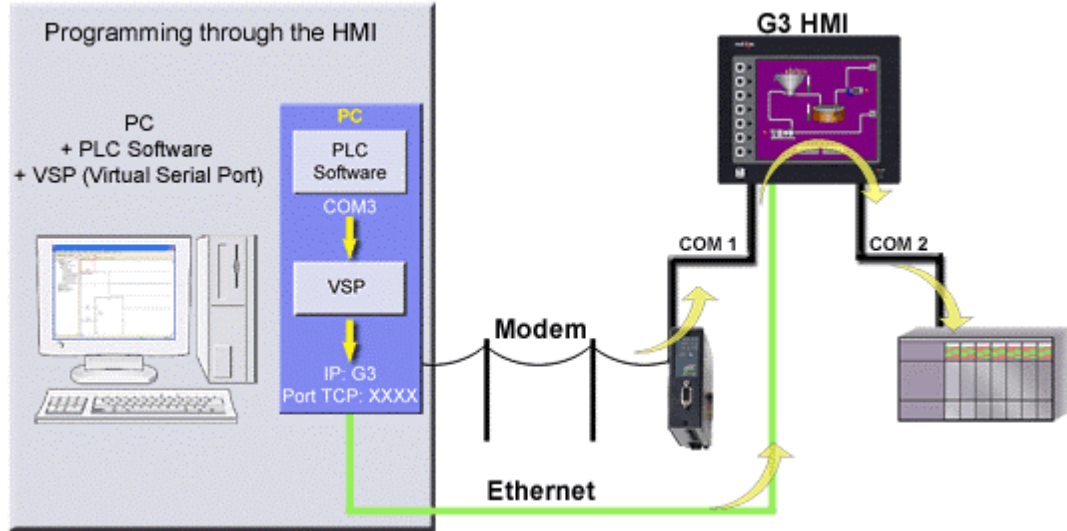

Pass-through programming is a unique feature, which allows you to program your connected devices remotely.\* Using either a modem or an Ethernet connection, you can reprogram your PLC, motor drive, etc. from anywhere in the world.

## BENEFITS

- Remotely maintain your application by accessing any serial devices connected to the HMI.
- Save time and money by solving simple problems remotely.

## EXAMPLE

A power generator manufacturer can remotely access his rental generator and upload the latest patch for his PLC. In case of a problem, PLC programs can be looked at, debugged and downloaded again.



# PASS-THROUGH PROGRAMMING IN JUST 7 STEPS

**Step 1** Enter the "Communications" module.



**Step 2** Select the driver for your PLC.

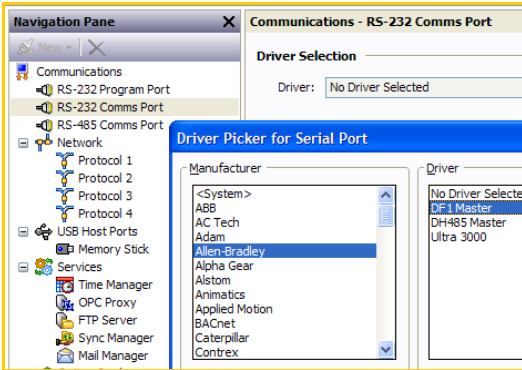

**Step 3** Share the port with a TCP socket.

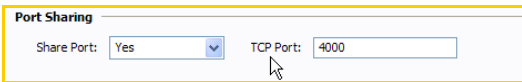

**Step 4** Enable the G3's Ethernet port.

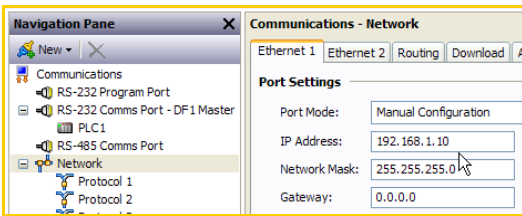

**Step 5** Run any VSP Software (Example below is TCP Com) and define the COM port your PLC software will be using.

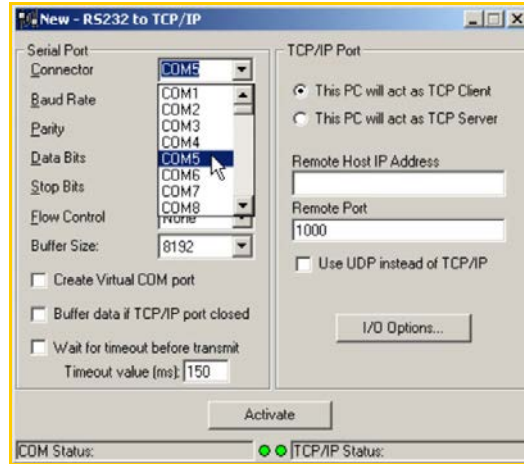

**Step 6** Define the host IP address, which is the G3, and the targeted TCP port.

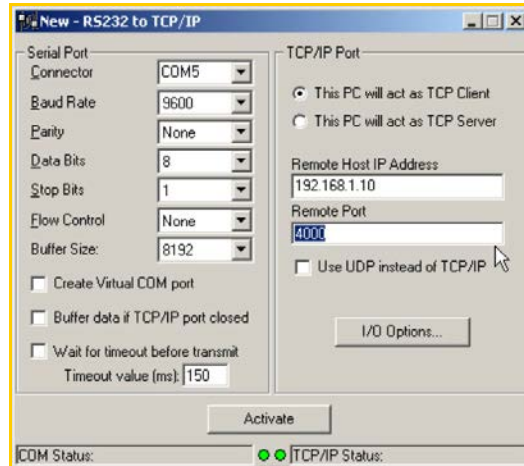

**Step 7** Activate the port.

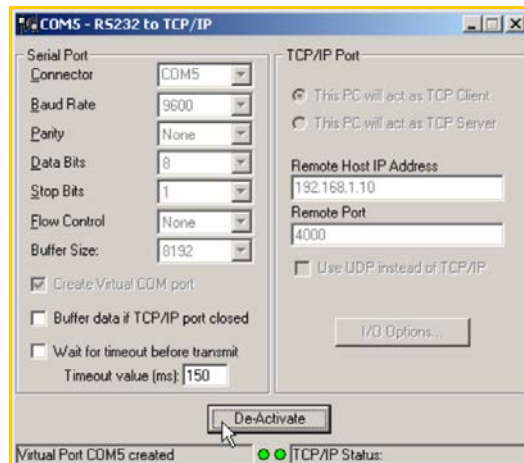

For more information on Crimson 3.0, refer to the manual.

\* Some PLCs do not support this feature. Profibus, CAN Open and DeviceNet do not support pass-through.

Your PLC software is now ready to use this virtual port as if it was connected directly to the PC.

# MODEM CONNECTIVITY

## DESCRIPTION



Access your system remotely with the G3's powerful modem connection capabilities. Connect to your equipment anywhere in the world via standard landline, GSM or GPRS modem.

## BENEFITS

- Remotely access your plant or system easily by just adding a modem.
- Remotely maintain your application from anywhere.
- Save time and money by using a simple RTC or GSM modem, no programming required.

## EXAMPLE

A remote mobile water treatment system does not have access to an ADSL line. Using a standard line and RTC modem, the main office is still able to remotely connect to the G3 web server. Operators can download data log files and initiate necessary action depending on the status.



# G3 ACCESS VIA LANDLINE MODEM IN JUST 8 STEPS

**Step 1** Enter the "Communications" module.



**Step 2** Select a serial port and choose the "PPP and Modem Server" driver.

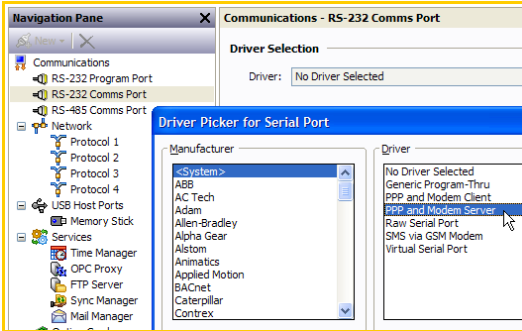

**Step 3** Select Generic Landline Modem.

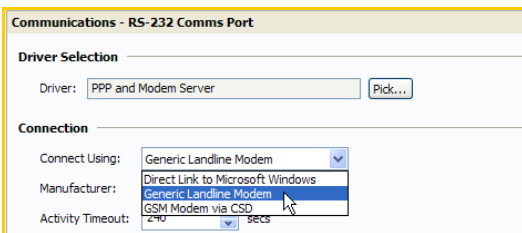

**Step 4** Enter a username and password to protect your connection.

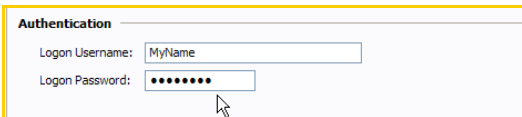

**Step 5** Enter the "Web Server" module.

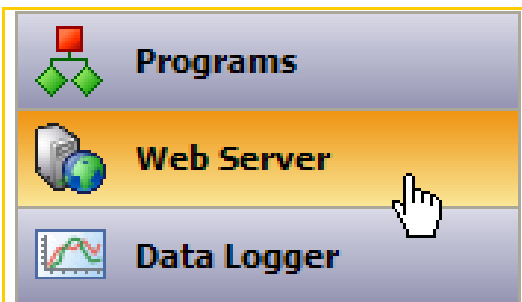

**Step 6** Activate the web server and choose the desired level of control.

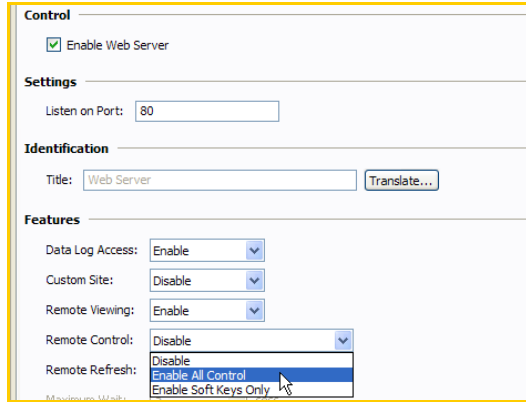

**Step 7** Create a connection on your PC for G3 access.

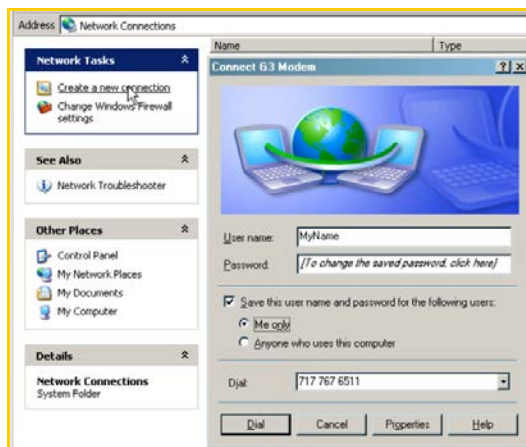

**Step 8** Call the G3 and run Internet Explorer to view the web server.

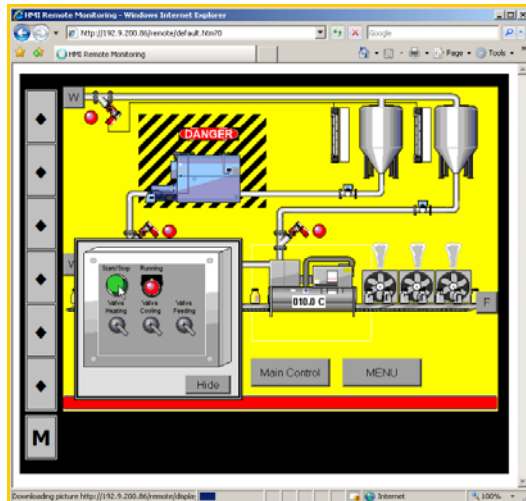

Modem connection complete!

For more information on Crimson 3.0, refer to the manual.

# SECURITY MANAGER

## DESCRIPTION

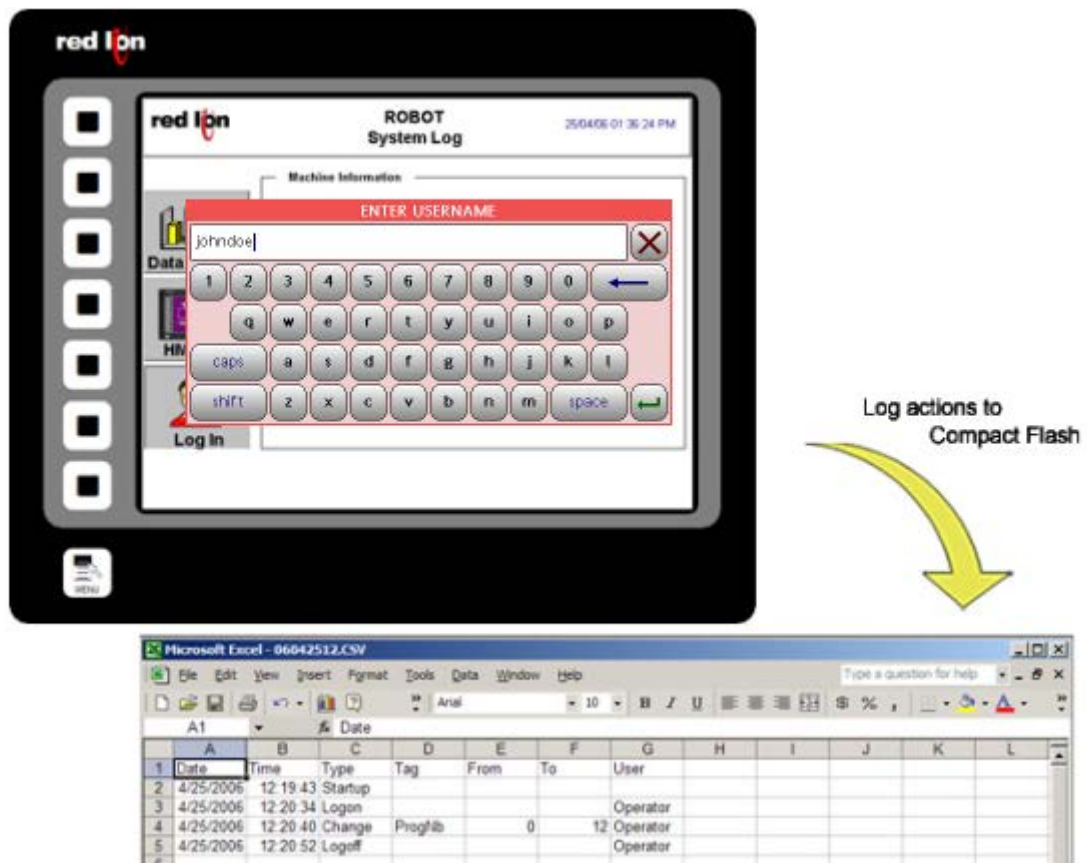

The Security manager provides multi-user, multilevel password protection. The advanced security logger tracks operator actions as well as any data changes for later review.

## BENEFITS

- Protect your machine from unauthorized operators and easily manage users.
- Log all users' actions for production follow up.
- Get the history of all your parameter modifications for faultfinding and maintenance.

## EXAMPLE

An OEM specializing in sterilization equipment provides his customer with multi-user password protection and logging for his system of autoclaves. This allows management to review operator access when quality issues arise.

# SECURE PAGE ACCESS IN 8 STEPS

**Step 1** Enter the Security Manager category.



**Step 2** Create a new user.

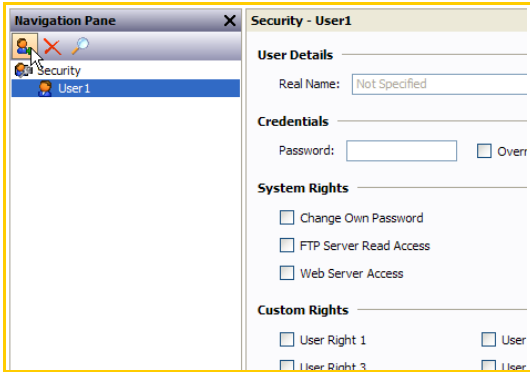

**Step 3** Enter a username and real name.

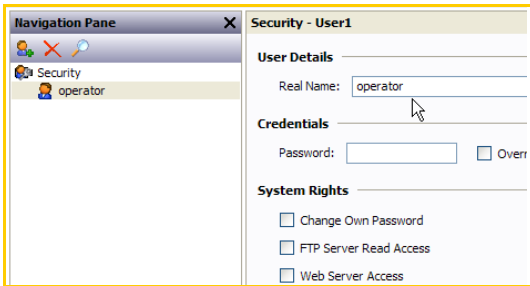

**Step 4** Set the password.

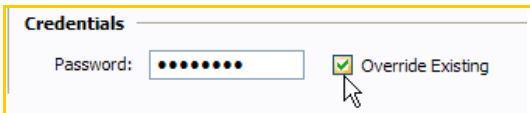

**Step 5** Assign user rights.

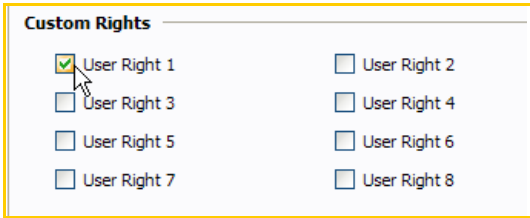

**Step 6** Enter the Display Pages category.



**Step 7** Select the page to protect and go to properties.

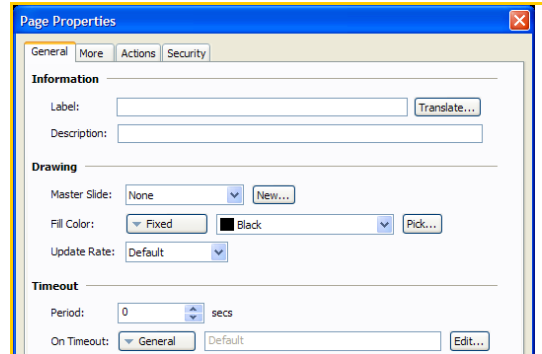

**Step 8** On the security tab, edit the access right for this page.

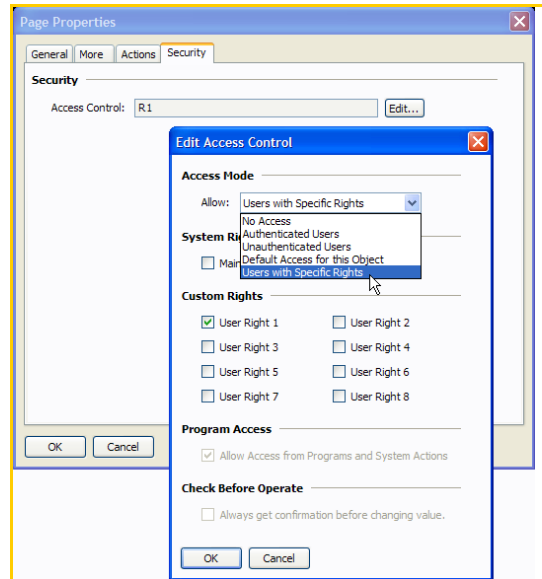

Only users with access right 1 can access the page. Attempts to access this page will result in a login popup window.

Security Manager setup complete!

For more information on Crimson 3.0, refer to the manual



# NON VOLATILE MEMORY

## DESCRIPTION



Using on-board flash, the G3 doesn't rely on a battery to maintain its database. No longer will your machine go down for the sake of a \$2.00 battery.

## BENEFITS

- Save all your recipes and system variables on board.
- No extra memory necessary on the PLC.

## RETENTIVE TAGS CONFIGURATION IN 4 STEPS

**Step 1** Enter the Data Tags category.



**Step 2** Create a variable.

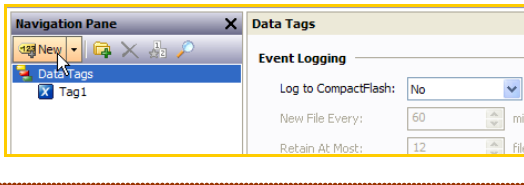

**Step 3** Select the variable.

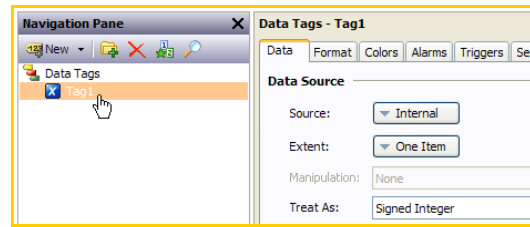

**Step 4** In the data tab, set the tag to retentive.

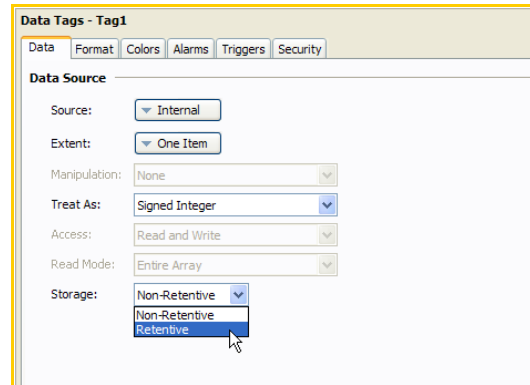

For efficiency, the G3 caches several minutes' worth of writes before committing to memory.

Retentive memory setup complete!

For more information on Crimson 3.0, refer to the manual.

# USB CONNECTION

## DESCRIPTION



The USB programming port allows you to download even the largest databases at blistering speeds. Crimson 3.0 uses incremental download to ensure that only changes to the database are transferred. This means that changes can be made in seconds, thereby reducing your development time and simplifying the debugging process.

With the decline of serially equipped PCs, particularly laptops, you won't be forced to keep that old laptop around.

The USB port also offers access to the CompactFlash card mounted on the G3, which appears as an extra drive in Windows environments. This provides full access to the CompactFlash card.

## BENEFITS

- Fast download allows easy testing when developing a database.
- No serial port necessary on your PC or laptop.
- Standard cable for simple connection.

## DOWNLOAD AND EXTRACT

**Step 1** Checkmark the Support Upload to allow future upload.

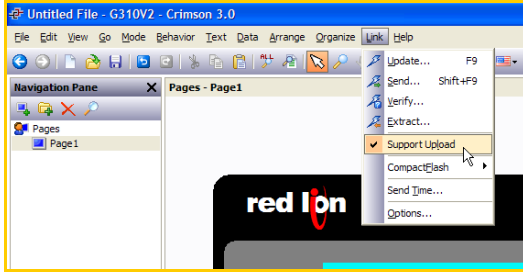

**Step 3** To upload a database, select the Extract menu item.

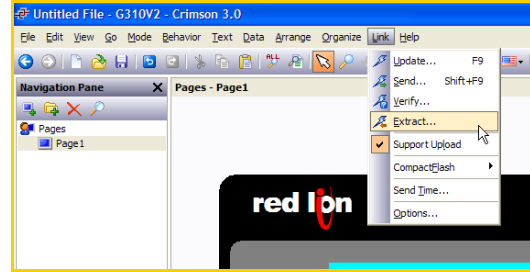

**Step 2** Download via the Link menu.

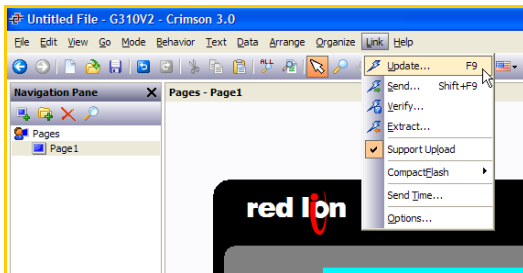

**Step 4** Once uploaded, Crimson 3.0 will prompt you to save the database.

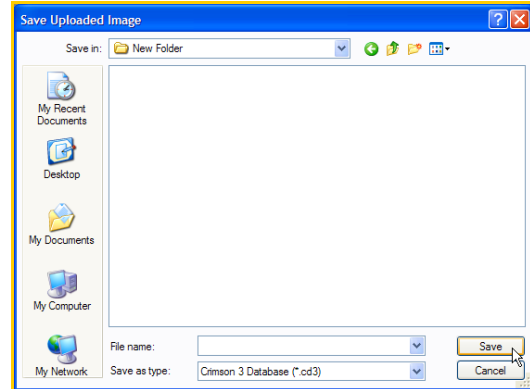

Download and extraction complete!

Retentive memory setup complete!

For more information on Crimson 3.0, refer to the manual.

# MATH AND FORMULAS

## DESCRIPTION

$$\bar{x} = \text{mean} = \frac{1}{n} \sum_{i=1}^n x_i = \frac{1}{n} (x_1 + \dots + x_n).$$



The screenshot shows a control panel with a 'Data Information' section containing the following data:

Category	Value
Total % Run Time	92.7%
StandOn	0.0
Green State	10.0
Total % Jam Time	0.2%
StandOn	1.2
Total % Trip Time	0.1%
StandOn	0.7
Total % Plug Time	1.1%
StandProgram	3.6
Total % Manual Time	0.0%
StandOn	0.0
Total % Miss Time	0.0%
StandOn	0.0

Below the data is a 'Data Source' field with a dropdown menu set to 'General' and a text input containing the formula: `float ((PV1 + PV2 + PV3) / 3)`. An 'Edit...' button is next to the input.

Mathematical diagrams include a sine wave graph with labels  $-\pi$ ,  $-\frac{1}{2}\pi$ ,  $0$ ,  $\frac{1}{2}\pi$ , and  $\pi$ . Other formulas shown are  $\sin \alpha = \frac{b}{r}$ ,  $\sigma = \sqrt{\frac{1}{N} \sum_{i=1}^N (x_i - \bar{x})^2}$ , and  $\text{AvgPV} = \frac{1}{N} \sum_{i=1}^N x_i$ .

Using 32-bit floating-point math, you can calculate downtime efficiency, production rates, process measurements for statistical analysis and operational equipment effectiveness (OEE).

## BENEFITS

- Manage your production by knowing its status.
- Easily calculate your system ratio, percentage and efficiency values.
- Control the G3 behavior from the HMI, making PLC programming easier.

## EXAMPLE

A production manager is interested in the efficiency of his soldering robots. Each robot is linked to a G3 that logs the robot status and actions. Calculations are then possible to find total downtime, number of solder joints per minute, robot efficiency, percentages on efficient usage, etc. An email is sent to the manager at the end of each day for his review.

## CREATING AND USING FORMULAS IN 6 STEPS

### Simple average calculation.

Step 1 Enter the "Data Tags" module.



Step 2 Create three tags.

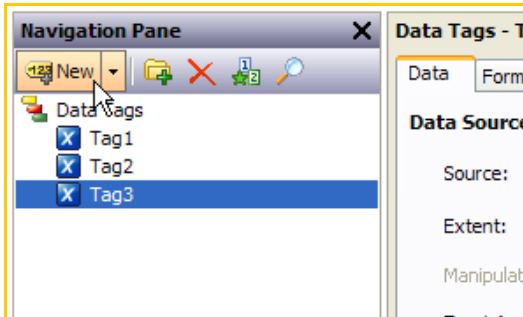

Step 3 Set the source for Tag3 to General.

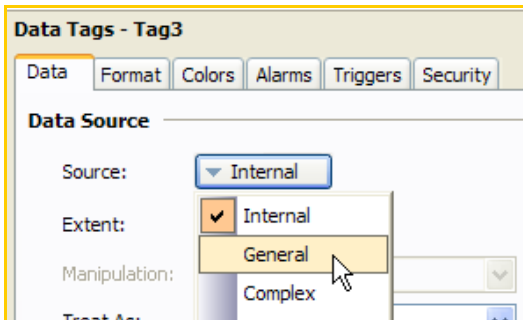

Step 4 Enter the equation.

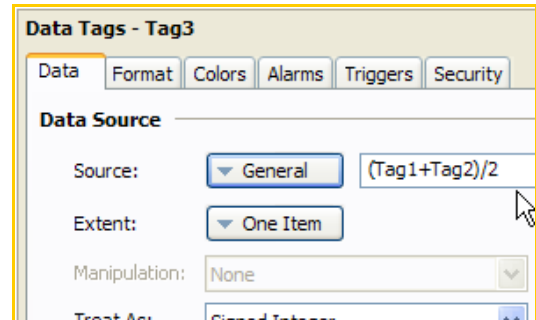

Step 5 Place the tags on the user interface.

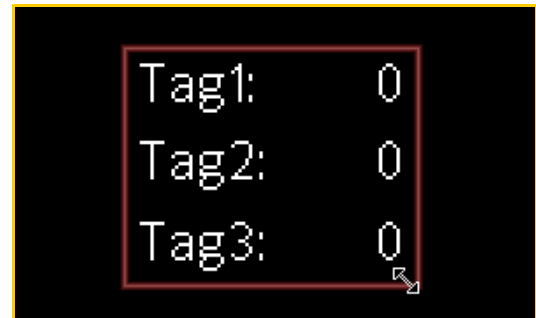

Step 6 Configure Tag1 and Tag2 as data entry.

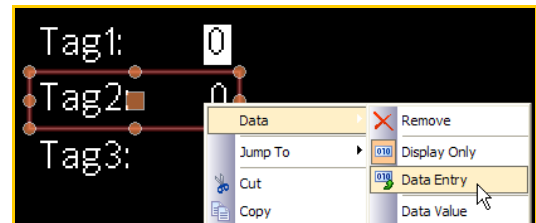

When the tag values change, the formula result follows.

Formula setup complete!

For more information on Crimson 3.0, refer to the manual.

# RECIPES AND ARRAYS

## DESCRIPTION

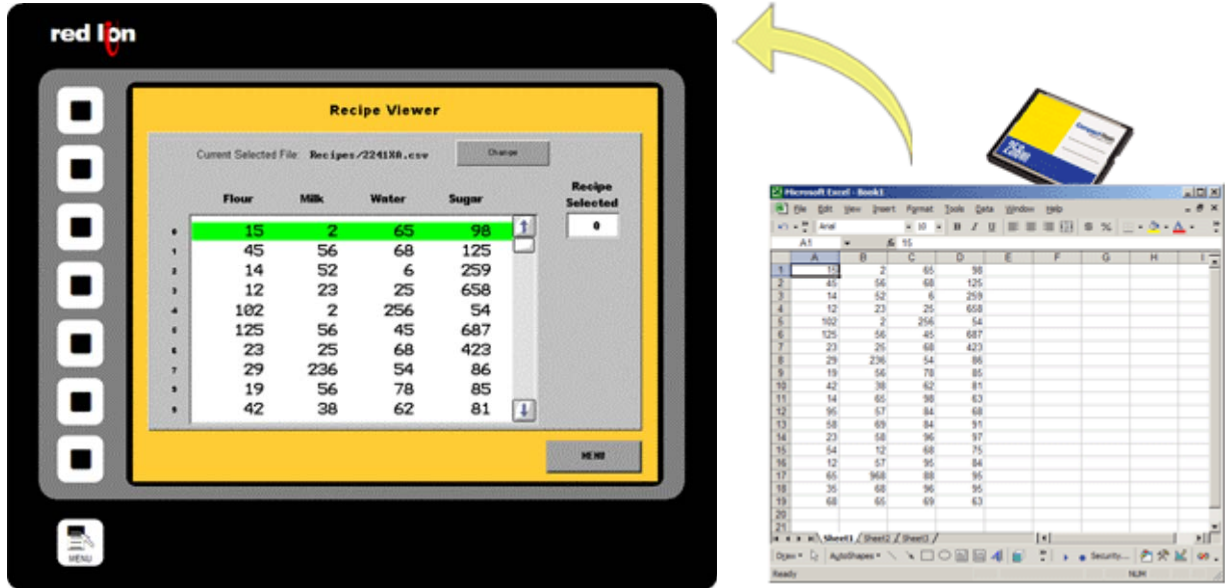

The G3's unique data handling capability provides all the necessary tools to manage recipes. You can load or download your process or batch-values to any of the communication devices linked to the HMI.

By storing the recipes to CompactFlash card, you can transfer your production data from one machine to another or from laboratory to production.

User programming is required to achieve recipe transfer with the CompactFlash card.

## BENEFITS

- Handle your different production batches with simplicity by just loading the right recipes.
- No extra PLC memory or complex mapping to create – everything is saved in the G3.
- Transfer recipes via CompactFlash card.

## EXAMPLE

A plant specializing in plastic extrusion uses up to 2000 different profiles. Each profile has specifications in colors, shape, density and plastic type. Before each batch, all specs are loaded from the recipes by simply typing the part number. If a new plastic is created, the laboratory provides the specs on a CompactFlash card in a CSV file; so entering the new data is not even necessary.

# CREATING A SIMPLE RECIPE FUNCTION IN 10 STEPS

**Step 1** Enter the Data Tags category.



**Step 2** Create four tags, and name them flour, milk, water and sugar.

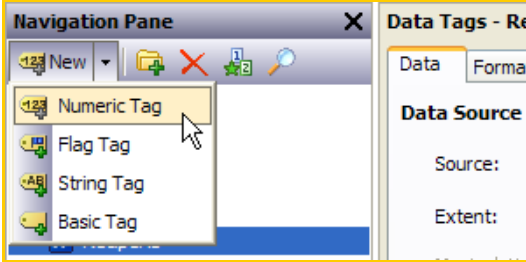

**Step 3** Set the extent property of each tag to 16. This will be the number of recipes.

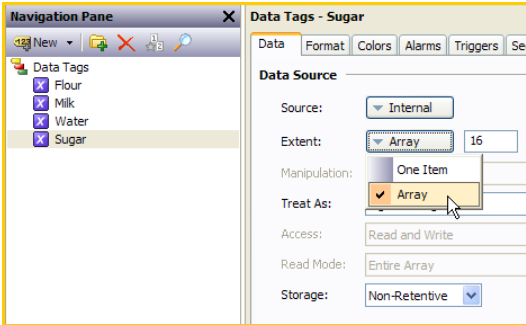

**Step 4** Create a tag representing the recipe number.

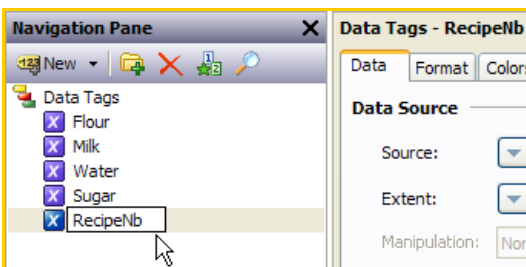

**Step 5** Place all of the tags on the user interface.

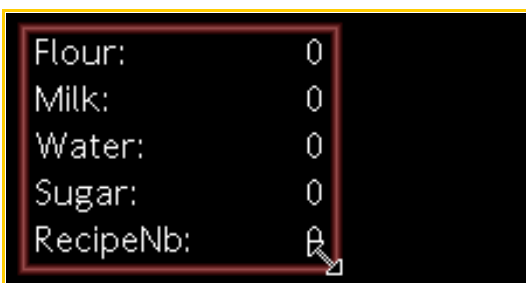

**Step 6** Set each tag primitive to data entry so that you can modify the recipe values.

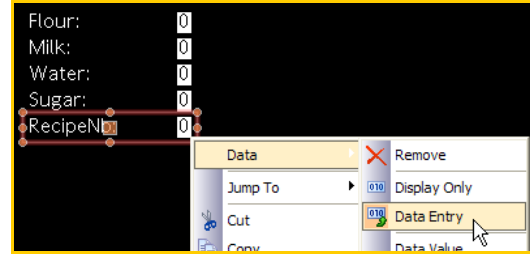

This example is now ready to use. Create recipes by changing values in the ingredients for a defined recipe number. Altering the recipe number will change the recipe being viewed.

Recipe setup complete!

For more information on Crimson 3.0, refer to the manual.



# BUILT IN COMPILER

## DESCRIPTION

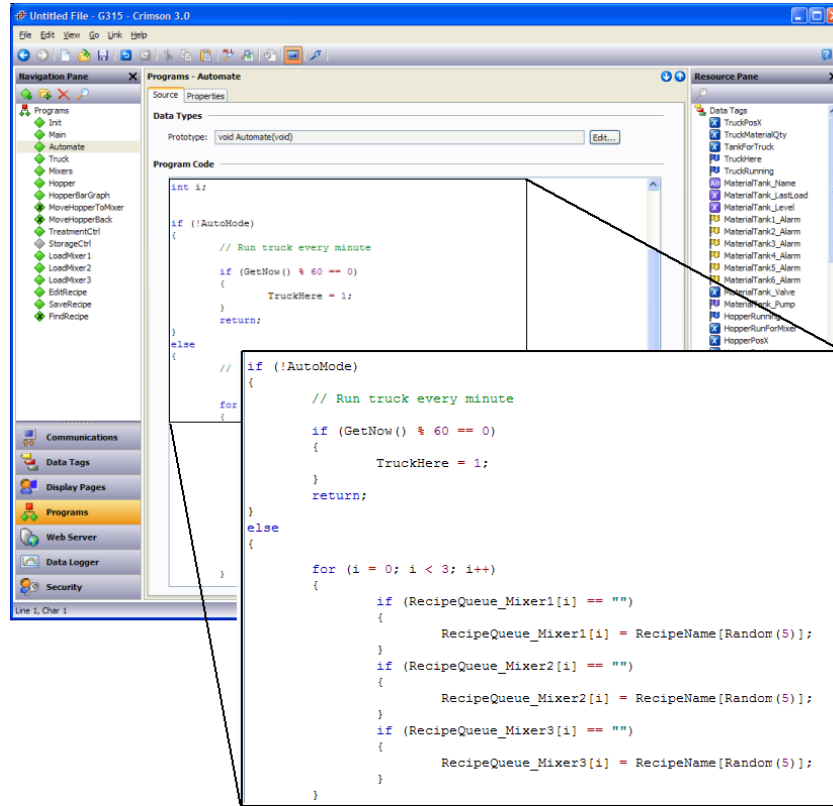

While we do our best to create the most powerful interface on the market, we can't always keep up with our customers' imaginations. We've thus included a powerful programming system to allow you to implement any additional functionality that your application may need. The C-like programming language features blistering performance, advanced math capability, and provides direct access to many of the G3's unique features, like the CompactFlash card and the multiple serial ports. You can even create TCP/IP connections to extract data from websites!

## BENEFITS

- Allows customer to write custom routines specific to their application, e.g. advanced calculations and logical expressions.

## CREATING A SIMPLE PROGRAM IN 10 STEPS

**Step 1** Create a numeric tag called "Counter".

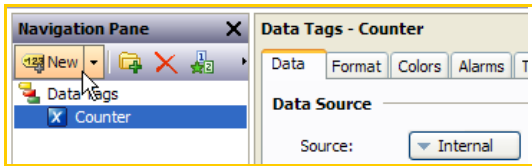

**Step 2** Create a flag tag called "Direction".

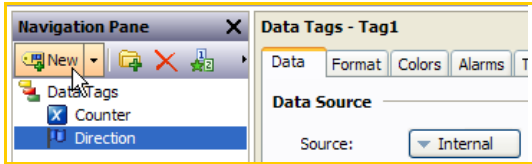

**Step 3** Enter the "Programming" module.

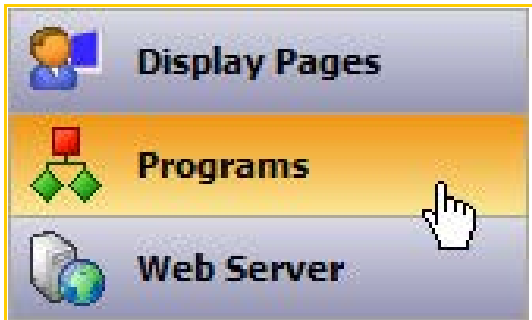

**Step 4** Insert the following code.

```

Program Code

if (Direction = 0) {
    Counter ++;
}

else {
    Counter --;
}
    
```

**Step 5** Compile the program.

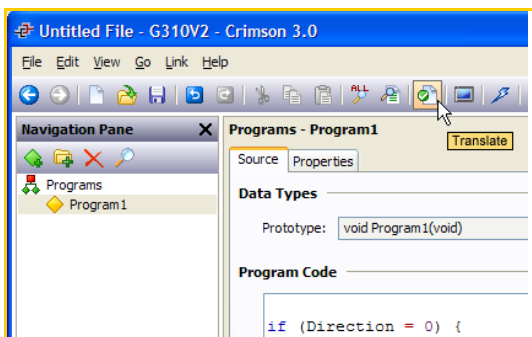

**Step 6** In the user interface, insert the counter tag on the display.

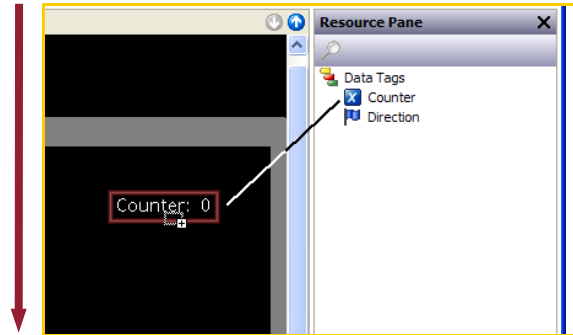

**Step 7** Then, insert a button.

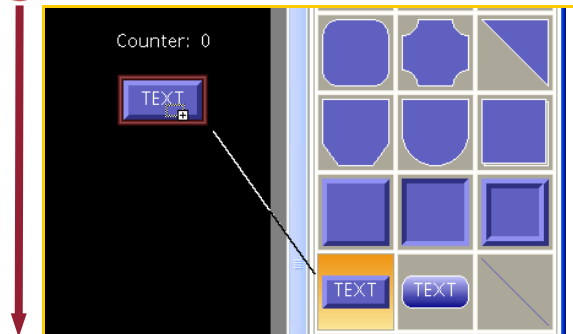

**Step 8** Program the button to toggle the Direction tag.



Steps 9 and 10 are on the following page.

**Step 9** Insert another button and label it “Run Program”.

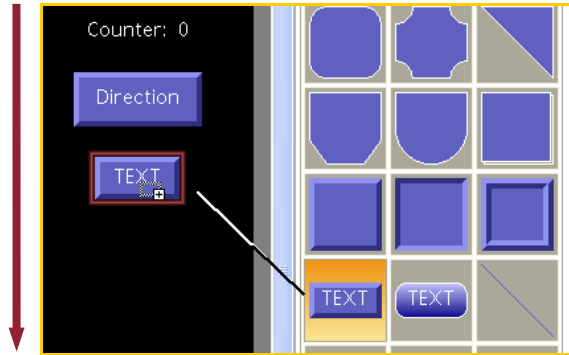

**Step 10** In the action tab, enter “Program1()”. This will execute the program once each press.

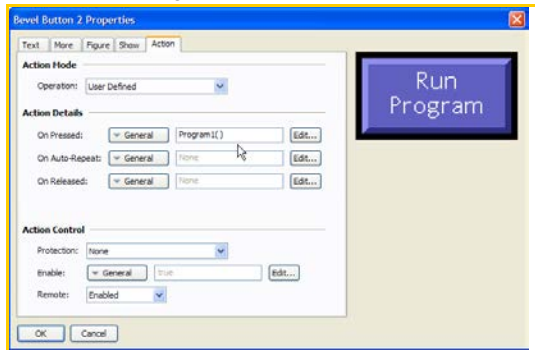

By changing the Direction tag value, the Counter will either increase or decrease when the program is executed.

Programming complete!

For more information on Crimson 3.0, refer to the manual.



# EVENT LOGGING

## DESCRIPTION

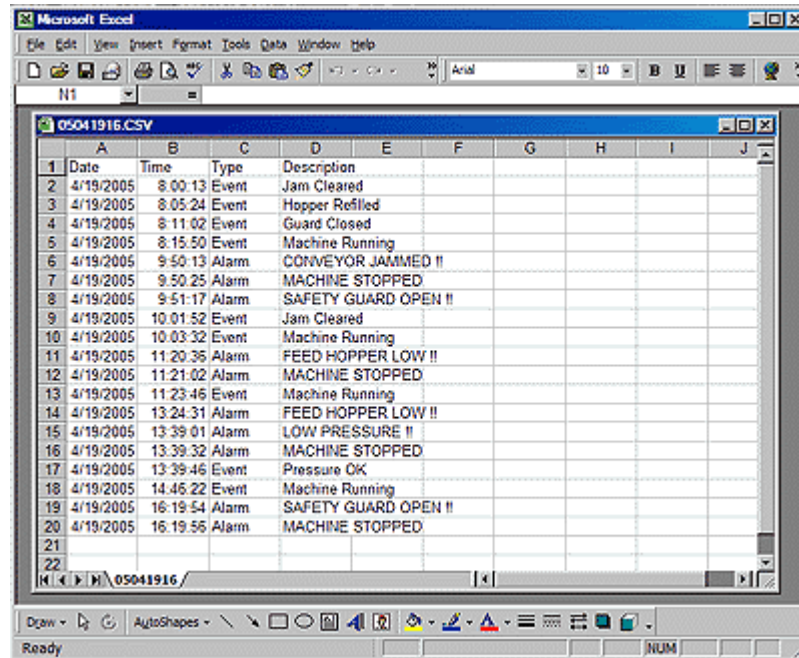

	A	B	C	D	E	F	G	H	I	J
1	Date	Time	Type	Description						
2	4/19/2005	8:00:13	Event	Jam Cleared						
3	4/19/2005	8:05:24	Event	Hopper Refilled						
4	4/19/2005	8:11:02	Event	Guard Closed						
5	4/19/2005	8:15:50	Event	Machine Running						
6	4/19/2005	9:50:13	Alarm	CONVEYOR JAMMED !!						
7	4/19/2005	9:50:25	Alarm	MACHINE STOPPED						
8	4/19/2005	9:51:17	Alarm	SAFETY GUARD OPEN !!						
9	4/19/2005	10:01:52	Event	Jam Cleared						
10	4/19/2005	10:03:32	Event	Machine Running						
11	4/19/2005	11:20:36	Alarm	FEED HOPPER LOW !!						
12	4/19/2005	11:21:02	Alarm	MACHINE STOPPED						
13	4/19/2005	11:23:46	Event	Machine Running						
14	4/19/2005	13:24:31	Alarm	FEED HOPPER LOW !!						
15	4/19/2005	13:39:01	Alarm	LOW PRESSURE !!						
16	4/19/2005	13:39:32	Alarm	MACHINE STOPPED						
17	4/19/2005	13:39:46	Event	Pressure OK						
18	4/19/2005	14:46:22	Event	Machine Running						
19	4/19/2005	16:19:54	Alarm	SAFETY GUARD OPEN !!						
20	4/19/2005	16:19:55	Alarm	MACHINE STOPPED						
21										
22										

The G3's event logger allows you to track machine events, providing critical information for troubleshooting and process improvement.

## BENEFITS

- Provides traceability for your system.
- History of your system helps maintenance to find the origin of problems.
- Built in event logger provides "IT-Ready" data in CSV file format.

## EXAMPLE

By monitoring events on a linear production line, the origin of a break in a process can be found in seconds and fixed as quickly as possible so production can resume.

# EVENT LOGGING IN 7 STEPS

**Step 1** Enter the Data Tags category.



**Step 2** Enable Log to CompactFlash.

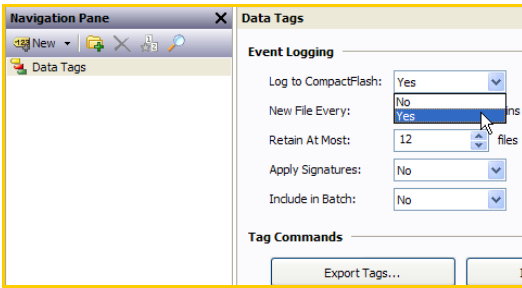

**Step 3** Create a flag tag.

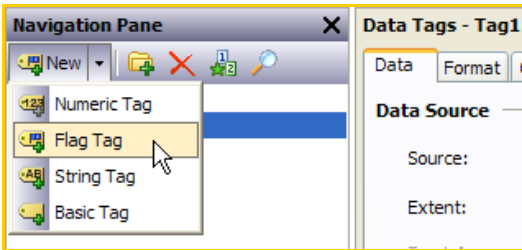

**Step 4** Configure an alarm. This alarm will automatically be logged as an event.

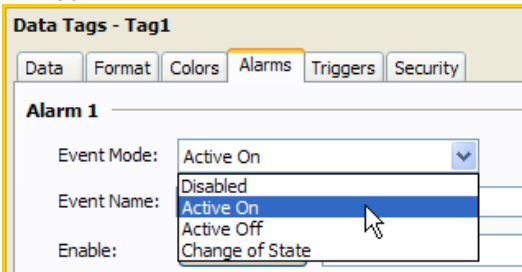

**Step 5** Enter the User Interface category.

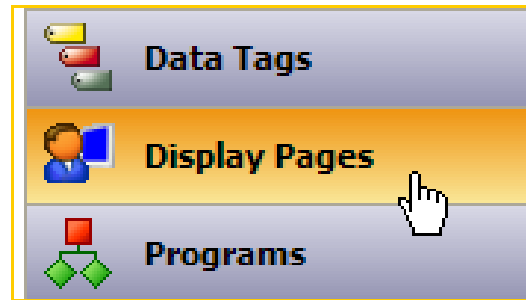

**Step 6** Place the flag tag on the user interface.

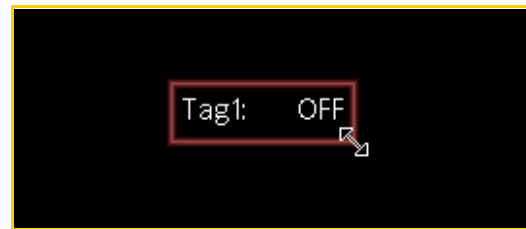

**Step 7** Place the Event Viewer on the user interface. The Event Viewer primitive is located within System Primitives on the Primitives resource pane.

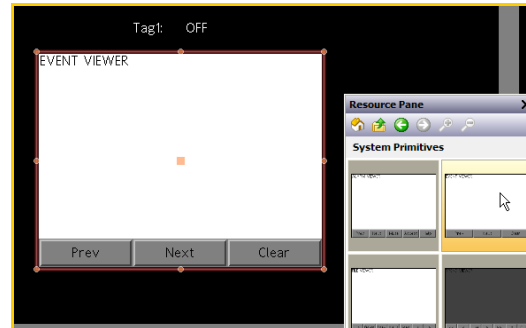

When the flag turns on, it will create an alarm, which is recorded in the event log and displayed by the Event Viewer. The viewer content is saved as a CSV file on the Compact Flash card.

Event Logging complete!

For more information on Crimson 3.0, refer to the manual.

# SECURITY LOGGING

## DESCRIPTION

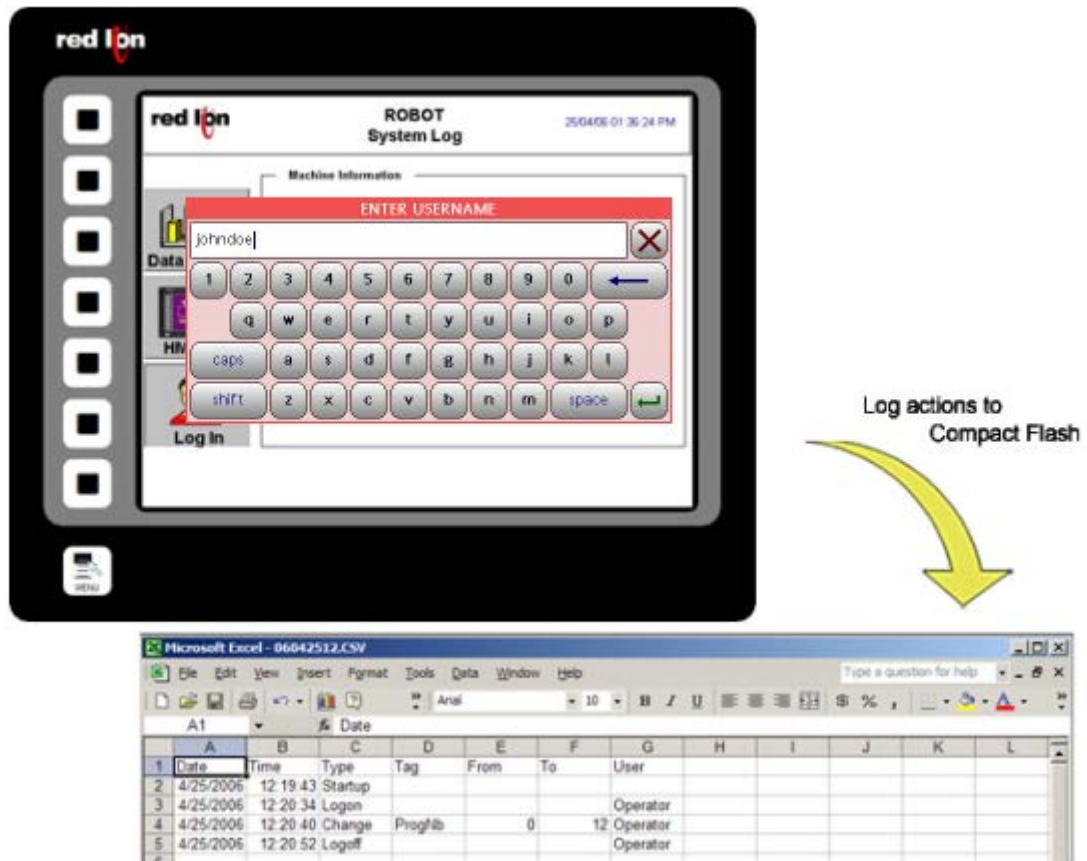

The Security Manager provides multi-user, multilevel password protection. The advanced security logger tracks operator actions as well as any data changes for later review.

## BENEFITS

- Protect your machine from unauthorized operators and manage users and rights easily.
- Log all user actions for production follow up.
- Get the history of all your parameter modifications for faultfinding and maintenance.

## EXAMPLE

An OEM specializing in sterilization equipment provides his customer with multi-user password protection for his autoclaves system. Production error due to operator failure can be found with the security logger. This allows management to review operator access when quality issues arise.

## SECURE PAGE ACCESS IN 8 STEPS

**Step 1** Enter the "Security Manager" module.



**Step 2** Create a new user.

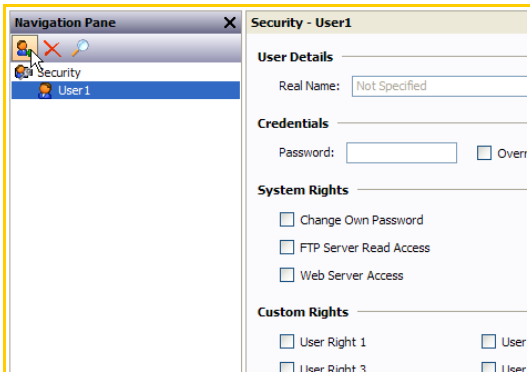

**Step 3** Enter a username and real name.

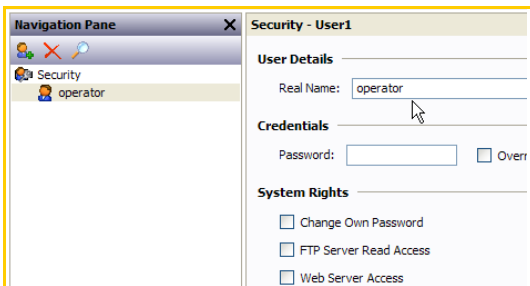

**Step 4** Set the password.

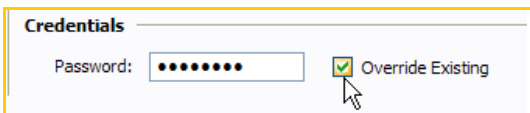

**Step 5** Assign user rights.

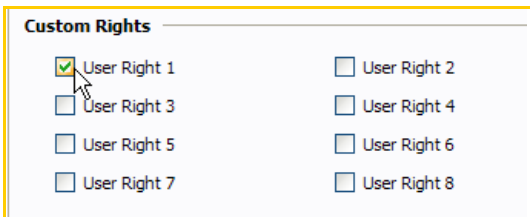

**Step 6** Define the data changes to be logged.

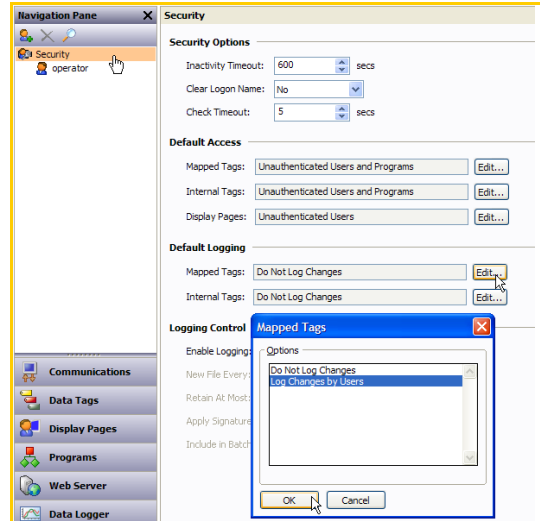

**Step 7** Enable the logging.

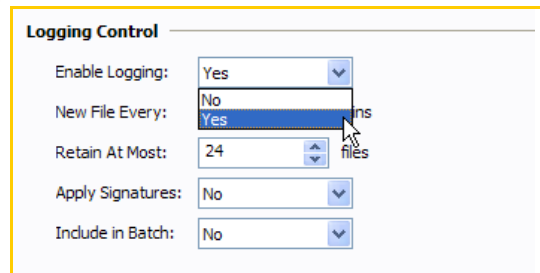

**Step 8** Enter the logging parameters.

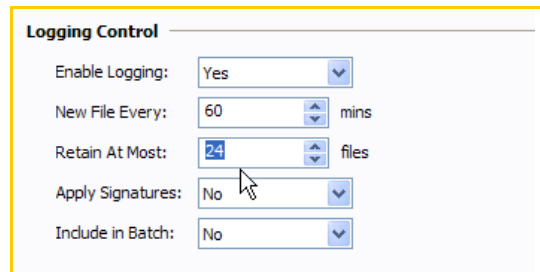

The security logger will now record users' actions and data changes.

Security Logger setup complete!

For more information on Crimson 3.0, refer to the manual



# COMPACTFLASH CARD ACCESS

## DESCRIPTION



Not only does the CompactFlash interface provide expandable storage for data and event logging, it also provides a means to load the panel's database without a PC. Through use of the User Programs portion of Crimson 3.0, users can create custom recipe and reporting structures.

## BENEFITS

- Use the memory card as a drive on your G3 and save any and all process data.
- Easily accessible using USB connection or FTP synchronization.
- Provide virtually unlimited memory for your reports, recipes, data, events and security logs.
- OEMs can send updates to their customers on CF card, allowing the customer to quickly change their program without a PC.

## EXAMPLE

A production manager in a bakery can access packaging line summary reports on his server for production numbers and shipping results. The reports are generated by G3s that synchronize with the server on a regular basis.

# USING C3 COMPACTFLASH TOOLS

## Mounting the CompactFlash card

**Step 1** Click on Link>CompactFlash>Mount Flash

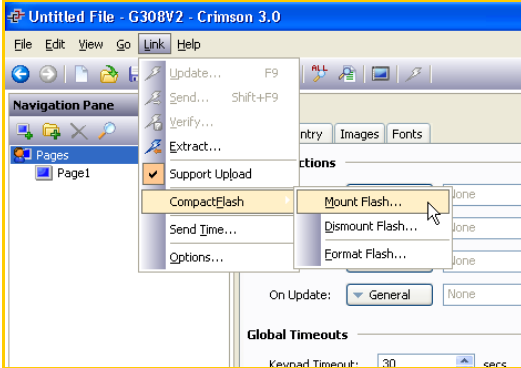

**Step 2** The G3 will cycle power to mount the card.

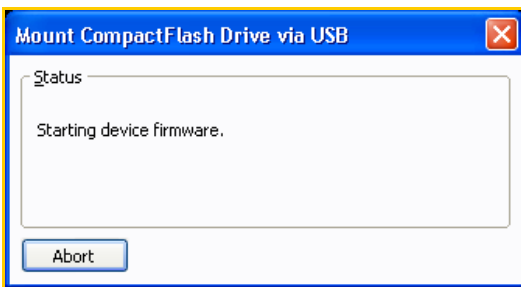

**Step 3** The card is then available as a drive under Windows Explorer.

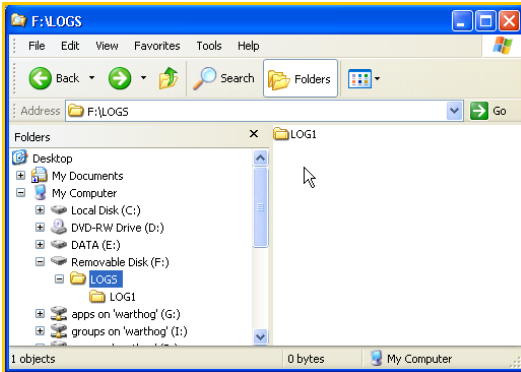

## Saving an image on the card

**Step 4** Click File>Save Image

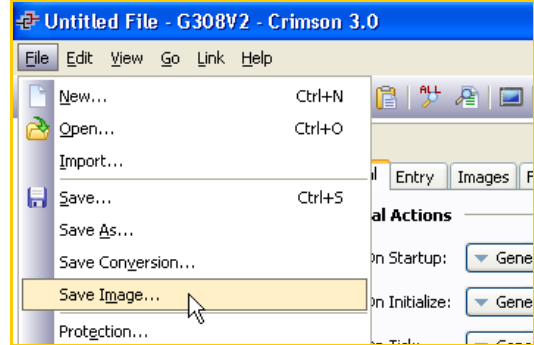

**Step 5** Select the CompactFlash Card and name the file image.ci3.

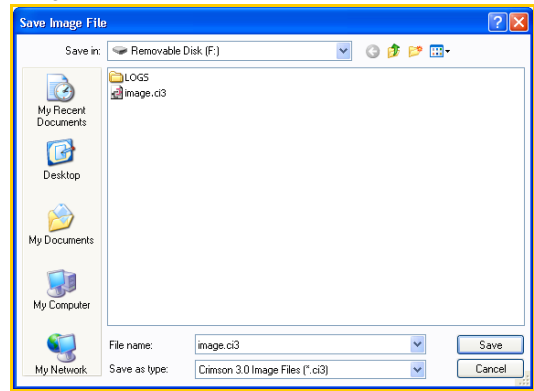

**Step 6** Click Yes to support upload.

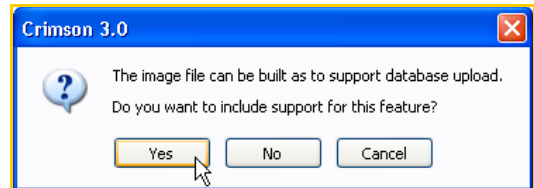

Cycling power to the G3 will cause it to load the configuration and firmware files contained in the image file.

Tutorial continues on next page.

## Formatting the CompactFlash card

**Step 7** Click on Link>CompactFlash>Format Flash

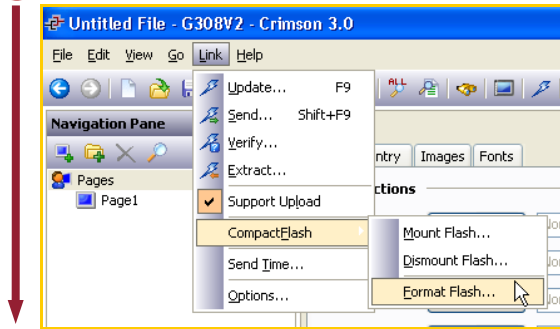

**Step 8** Crimson 3.0 will require confirmation.



**Step 9** The formatting window will stay until the CompactFlash is formatted.



## Dismounting the CompactFlash card

**Step 10** Click Link>CompactFlash>Dismount Flash

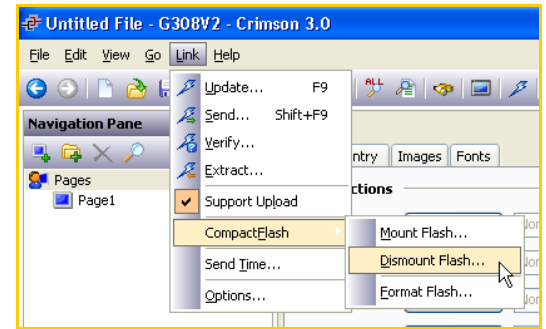

CompactFlash walkthrough complete!

For more information on Crimson 3.0, refer to the manual.



# EMULATOR

## DESCRIPTION



The Emulator provides a unique facility to design and test your application. This not only allows you to test the user interface portion of your G3 HMI configuration; it also allows you to test data logging and even the web server!

## BENEFITS

- Test your database directly on computer; no hardware required.
- View the web server and log files to preview data available for your customer.
- Simplify database development and save time by testing your program enhancement straight away.

## EXAMPLE

A special purpose machine manufacturer develops a new database for each new project. The emulator gives him the opportunity to review and test his database design before hardware delivery, saving time when performing on-site commissioning.

## SETTING UP THE EMULATOR

**Step 1** Click on Link>Options

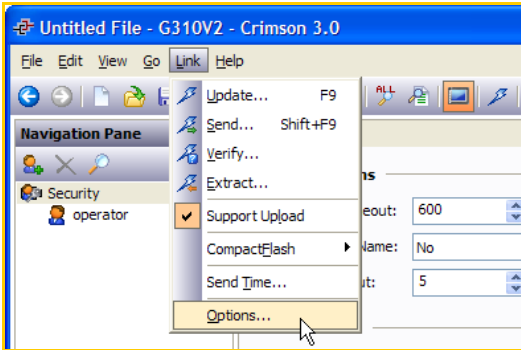

**Step 2** Select "Send to Emulator".

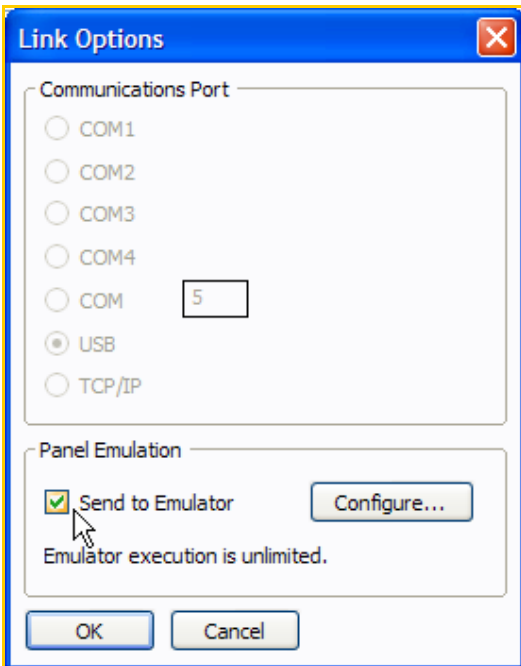

**Step 3** Click on Link>Update or F9 to download your application in the Emulator.

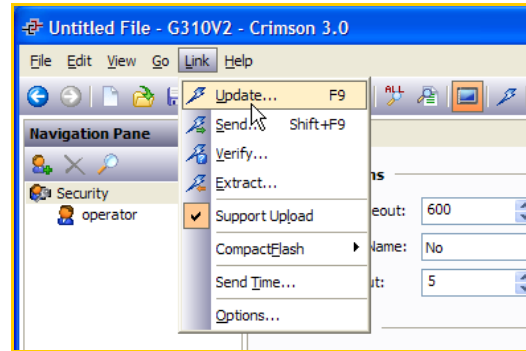

**Step 4** The emulated G3 pops up on your PC screen.

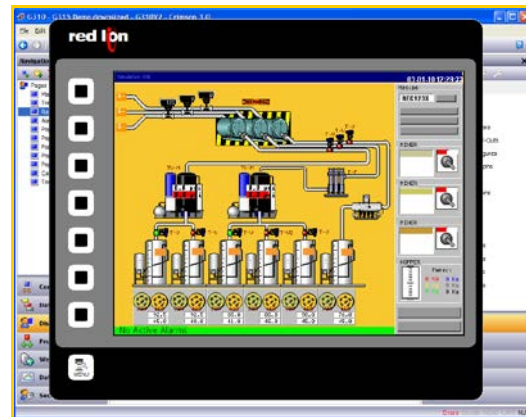

Emulator setup complete!

For more information on Crimson 3.0, refer to the manual.

# USB MEMORY STICK SUPPORT

## DESCRIPTION



Several models of the G3 series HMIs offer dual USB host ports for support of various devices, including USB memory sticks.

The G3 can be configured to automatically synchronize files to and from the CF card for fast file transfers. The G3 may also be configured to automatically retrieve a new configuration file, as well as the necessary firmware files, to change the unit's configuration without a PC.

## BENEFITS

- Retrieve the data log files using a USB memory stick.
- Transfer new recipe information to the panel's CF card without a PC.
- Update the unit's configuration via USB memory stick.

## EXAMPLE

A customer can have an employee visit their remote sites to retrieve log files, as well as to update any recipe information, while simultaneously updating the unit's configuration file to the latest revision. The employee need not have a PC, or any training regarding the use of Crimson – a simple memory stick is all that is required.

# CONFIGURING USB MEMORY STICK SUPPORT

## Configuration and Firmware Updates

**Step 1** Enter the Communications category.



**Step 2** Select Memory Stick, and enable it.

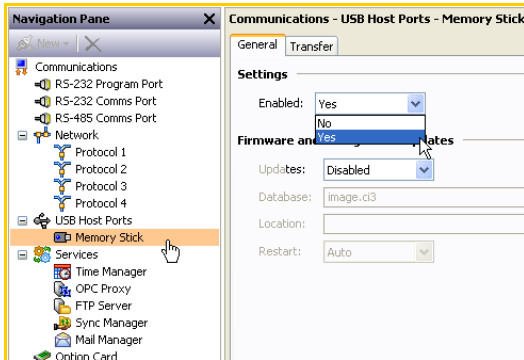

**Step 3** Enable configuration updates.

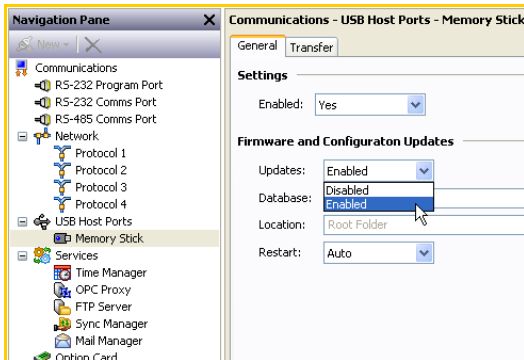

**Step 4** Enter the file name that the HMI should look for when the USB stick is plugged in.

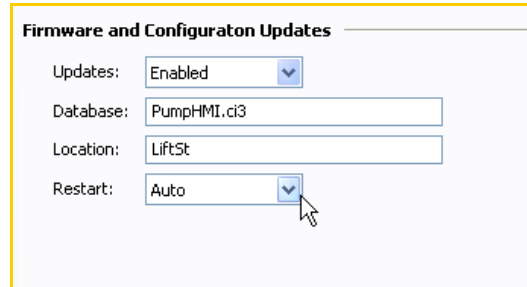

**Step 5** Select whether the unit should restart on its own, or if the operator will restart it later.

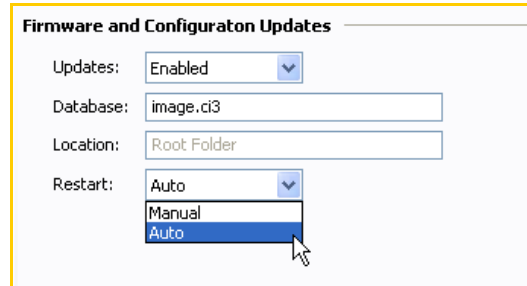

**Step 6** Download this configuration to the unit.

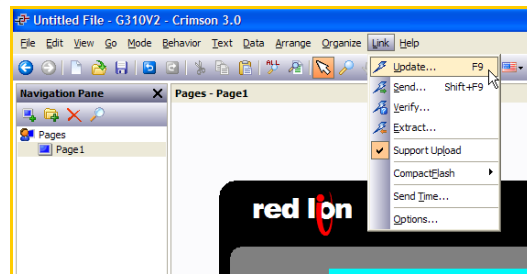

If a memory stick containing a Crimson 3 image file is inserted into the unit's USB host port, the unit will automatically upload and assume the new configuration. (Memory stick must be formatted as FAT.)

Tutorial continues on next page.



## Synchronizing log files to memory stick

**Step 7** Set the Transfer property to “Copy Files and Folders”.

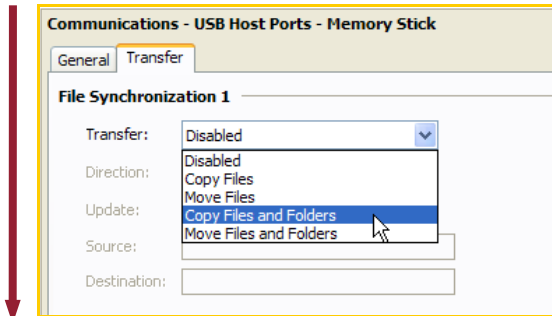

**Step 8** Set the Direction property to “CompactFlash to Memory Stick.”

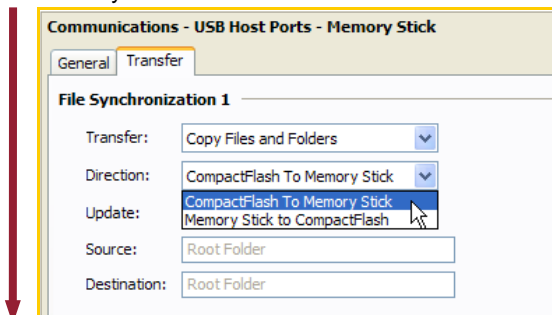

**Step 9** Enter “Logs” for the Source, and a desired folder name for the Destination.

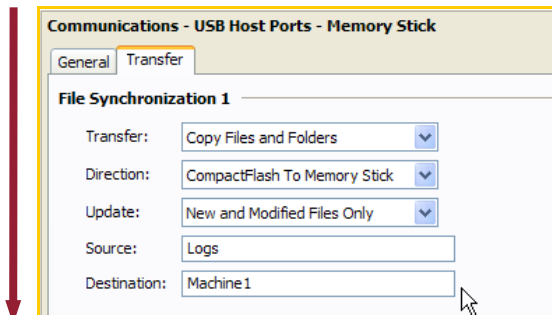

When a FAT formatted memory stick is connected, the G3 will automatically synchronize the logs files to the stick in a folder called Machine1.

For more information on Crimson 3.0, refer to the manual.



# ONLINE TAG VIEWING

## DESCRIPTION

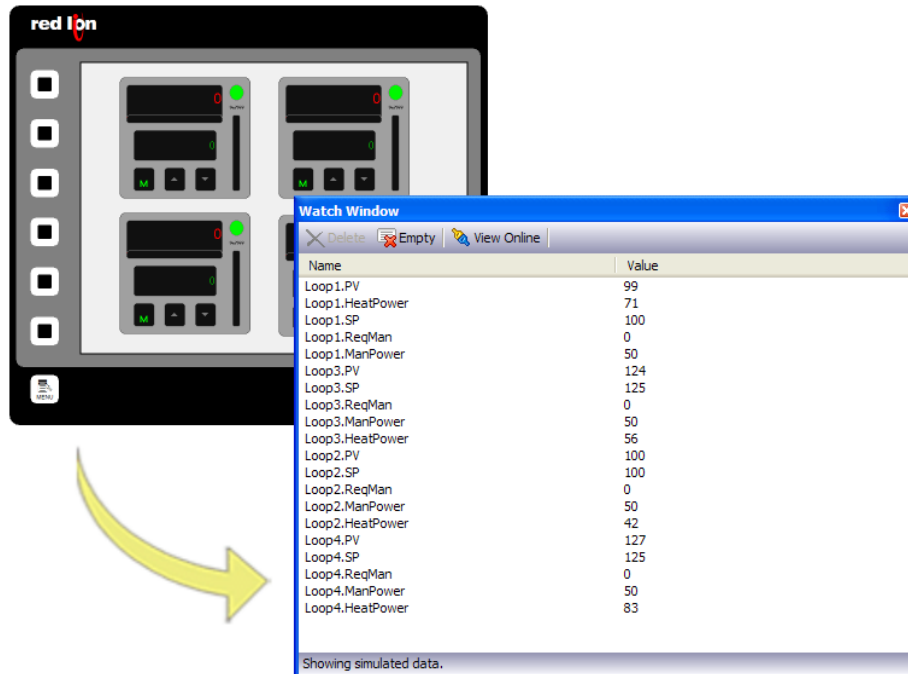

With the Watch List feature, tags can be viewed live within Crimson 3. Viewing tags live offers an easy means of troubleshooting problems, reducing development time.

## BENEFITS

- Reduce development time by verifying that the data is valid.
- View tags over Ethernet to troubleshoot systems remotely.

## EXAMPLE

A technician uses the Watch Window to quickly find tag-mapping errors by comparing the PLC's data with the G3's tags, saving valuable commissioning time.

# ONLINE TAG VIEWER – WATCH LIST

## Tags category access

**Step 1** Enter the Data Tags category.



**Step 2** Right-click the tag(s), or an entire folder of tags, and select "Add to Watch List."

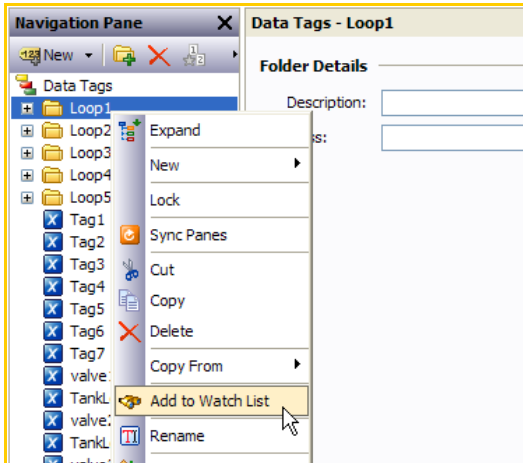

**Step 3** Click View Online to view the live data.

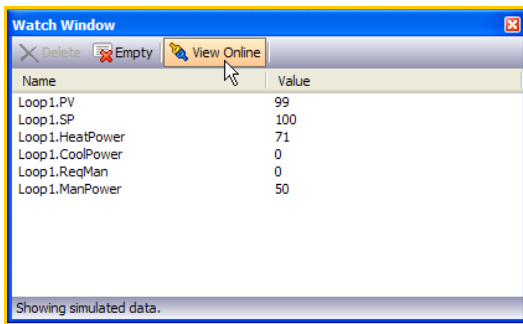

## Page category access

**Step 4** Enter the Display Pages category.



**Step 5** Right-click a page, and select Watch Page.

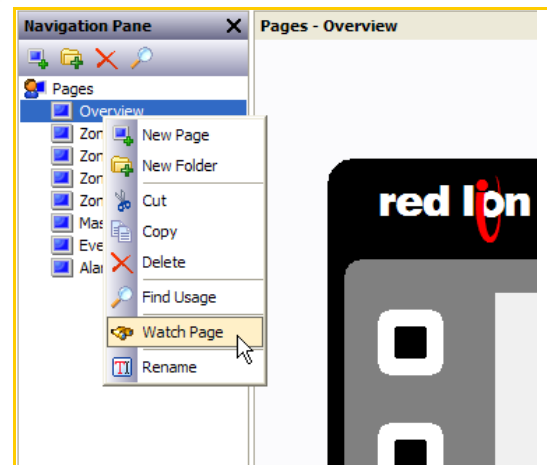

**Step 6** Click View Online to view the live data.

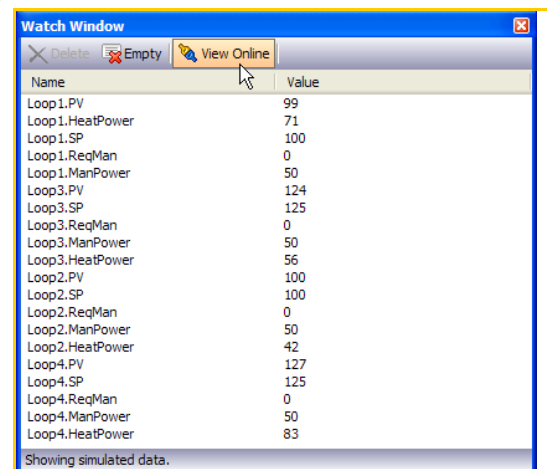

The live data appears in the watch window!

For more information on Crimson 3.0, refer to the manual.

# PLATFORM CONVERSION

## DESCRIPTION

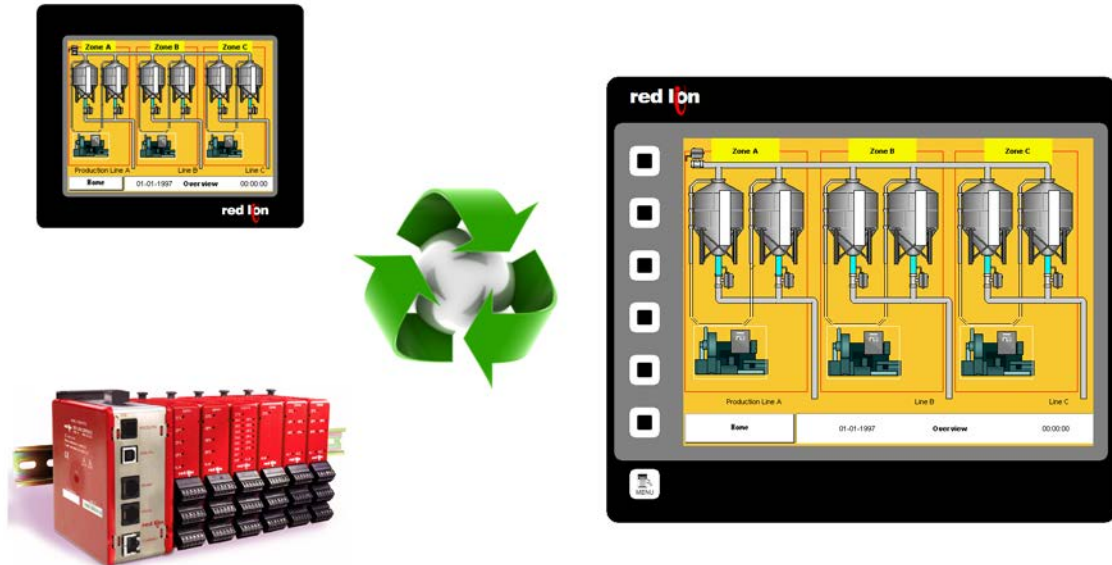

The platform conversion utility allows you to reuse your development efforts on various Red Lion platforms. Databases can be converted for use between the G3, G3 Kadet, Data Station and Modular Controller series of products.

## BENEFITS

- Reduce development time by reusing your files in various Red Lion products.

## EXAMPLE

An OEM builds a range of machines with varying price points and capability. His high-end machines are fitted with the powerful ten-inch G3, while the basic machines need only the functionality provided by the six-inch G3 Kadet. Equipment destined for remote, unmanned facilities use only the virtual HMI provided by the Data Station Plus.

Crimson's platform conversion utility allows the developer to create one file, which can then be converted for use in all of Red Lion's interface products.

# PLATFORM CONVERSION

**Step 1** Open a file, then select File->Save Conversion.

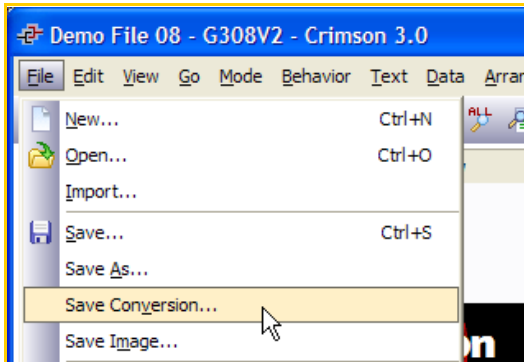

**Step 3** Provide a new name for the converted file.

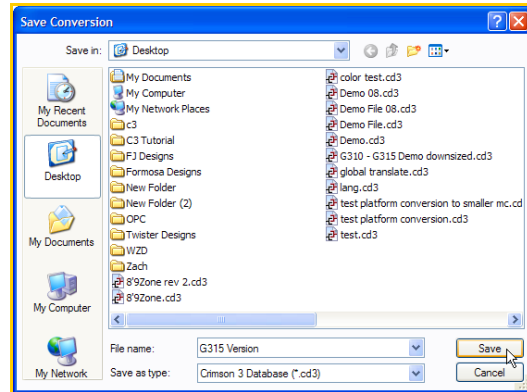

**Step 2** Select the desired Family and Model type, and click Convert.

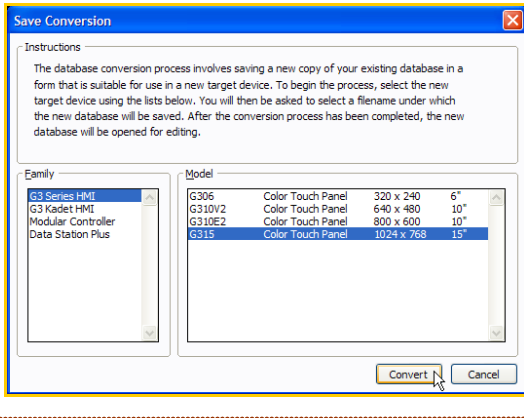

Platform conversion complete.

For more information on Crimson 3.0, refer to the manual.

